



Static and Dynamic Balancing of Rigid Rotors



Static and Dynamic Balancing of Rigid Rotors

by Macdara MacCamhaoil
Brüel & Kjær

Introduction

Unbalance is the most common source of vibration in machines with rotating parts. It is a very important factor to be considered in modern machine design, especially where high speed and reliability are significant considerations. Balancing of rotors prevents excessive loading of bearings and avoids fatigue failure, thus increasing the useful life of machinery.

This Application Note will demonstrate how simple and straight-forward it is to balance rigid rotors in situ using portable Brüel & Kjær instruments.

Brüel & Kjær balancing machines that accept rotating parts for production-line balancing and laboratory use are described in separate publications.

Basic Theory and Definitions

Unbalance in a rotor is the result of an uneven distribution of mass, which causes the rotor to vibrate. The vibration is produced by the interaction of an unbalanced mass component with the radial acceleration due to rotation, which together generate a centrifugal force. Since the mass component rotates, the force also rotates and tries to move the rotor along the line of action of the force. The vibration will be transmitted to the rotor's bearings, and any point on the bearing will experience this force once per revolution.

Balancing is the process of attempting to improve the mass distribution of a rotor, so that it rotates in its bearings without uncompensated

centrifugal forces. This is usually done by adding compensating masses to the rotor at prescribed locations. It can also be done by removing fixed quantities of material, for example by drilling.

Field Balancing is the process of balancing a rotor in its own bearings and supporting structure, rather than in a balancing machine.

Static Unbalance is defined as the eccentricity of the centre of gravity of a rotor, caused by a point mass at a certain radius from the centre of rota-

tion (see Fig. 1). An equal mass, placed at an angle of 180° to the unbalanced mass and at the same radius, is required to restore the centre of gravity to the centre of rotation. **Static Balancing** involves resolving primary forces into one plane and adding a correction mass in that plane only. Many rotating parts which have most of their mass concentrated in or very near one plane, such as flywheels, grindstones, car wheels, etc., can be treated as static balancing problems. If a rotor has a diameter of more than 7 to 10 times its width, it is usually treated as a single-plane rotor.

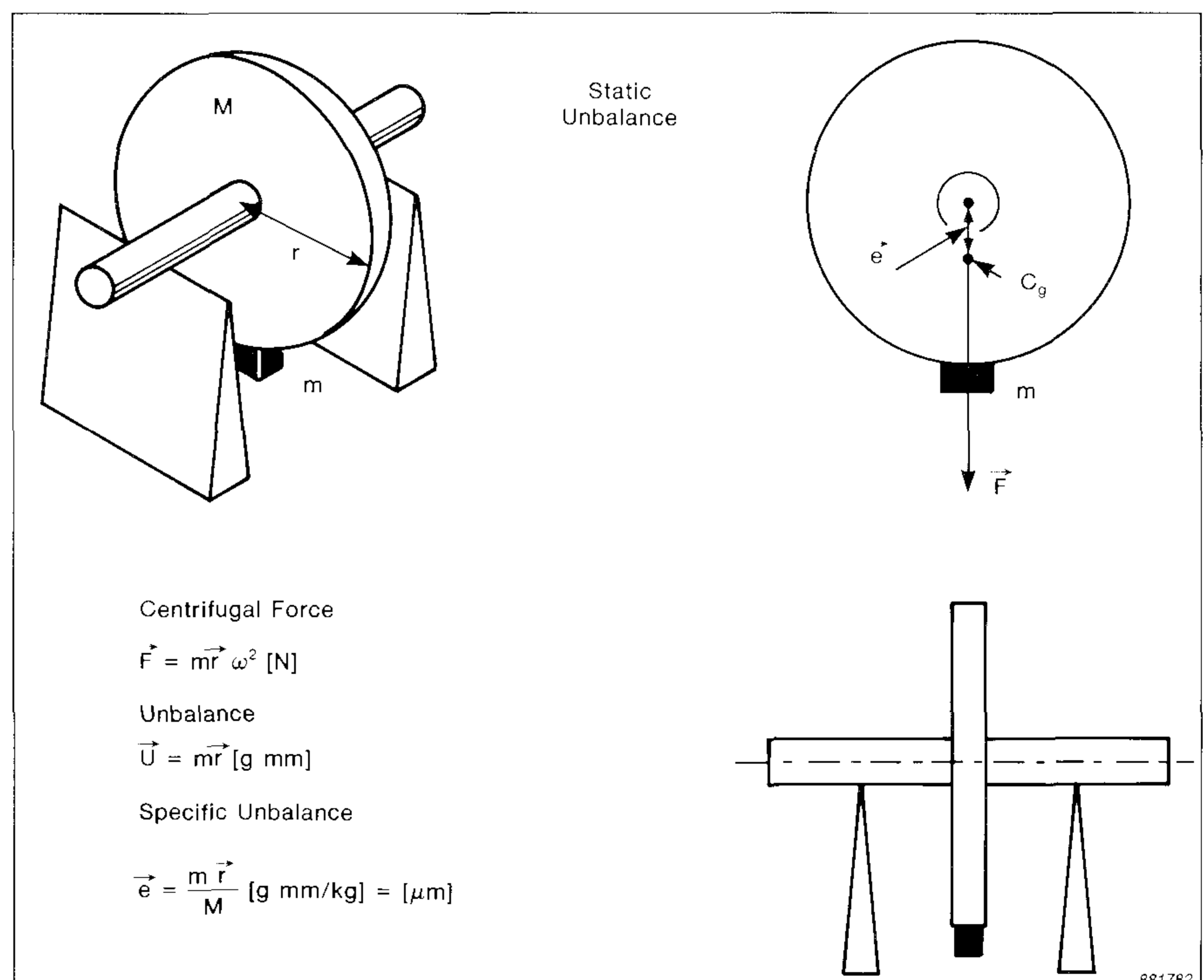

Fig. 1. Static unbalance

Couple (Moment) Unbalance may be found in a rotor whose diameter is less than 7 to 10 times its width. In the case of a cylinder, shown in Fig. 2, it is possible to have two equal masses placed symmetrically about the centre of gravity, but positioned at 180° from each other. The rotor is in static balance, i.e. there is no eccentricity of the centre of gravity, but when the rotor turns, the two masses cause a shift in the inertia axis, so that it is no longer aligned with the rotation axis, leading to strong vibrations in the bearings. The unbalance can only be corrected by taking vibration measurements with the rotor turning and adding correction masses in two planes.

The difference between static balance and couple balance is illustrated in Fig. 3. It can be seen that when the rotor is stationary, the end masses balance each other. However, when it rotates, a strong unbalance is experienced.

Dynamic Unbalance, illustrated in Fig. 4, is a combination of static and couple unbalance and is the most common type of unbalance found in rotors. To correct dynamic unbalance, it is necessary to make vibration measurements while the machine is running and to add balancing masses in two planes.

Rotors are classified as being either **rigid** or **flexible**. This Application Note is concerned with **rigid** rotors only. A **rigid** rotor is one whose service speed is less than 50% of its first critical speed. Above this speed, the rotor is said to be **flexible**. A rigid rotor can be balanced by making corrections in any two arbitrarily selected planes. The balancing procedure for flexible rotors is more complicated, because of the elastic deflections of the rotor.

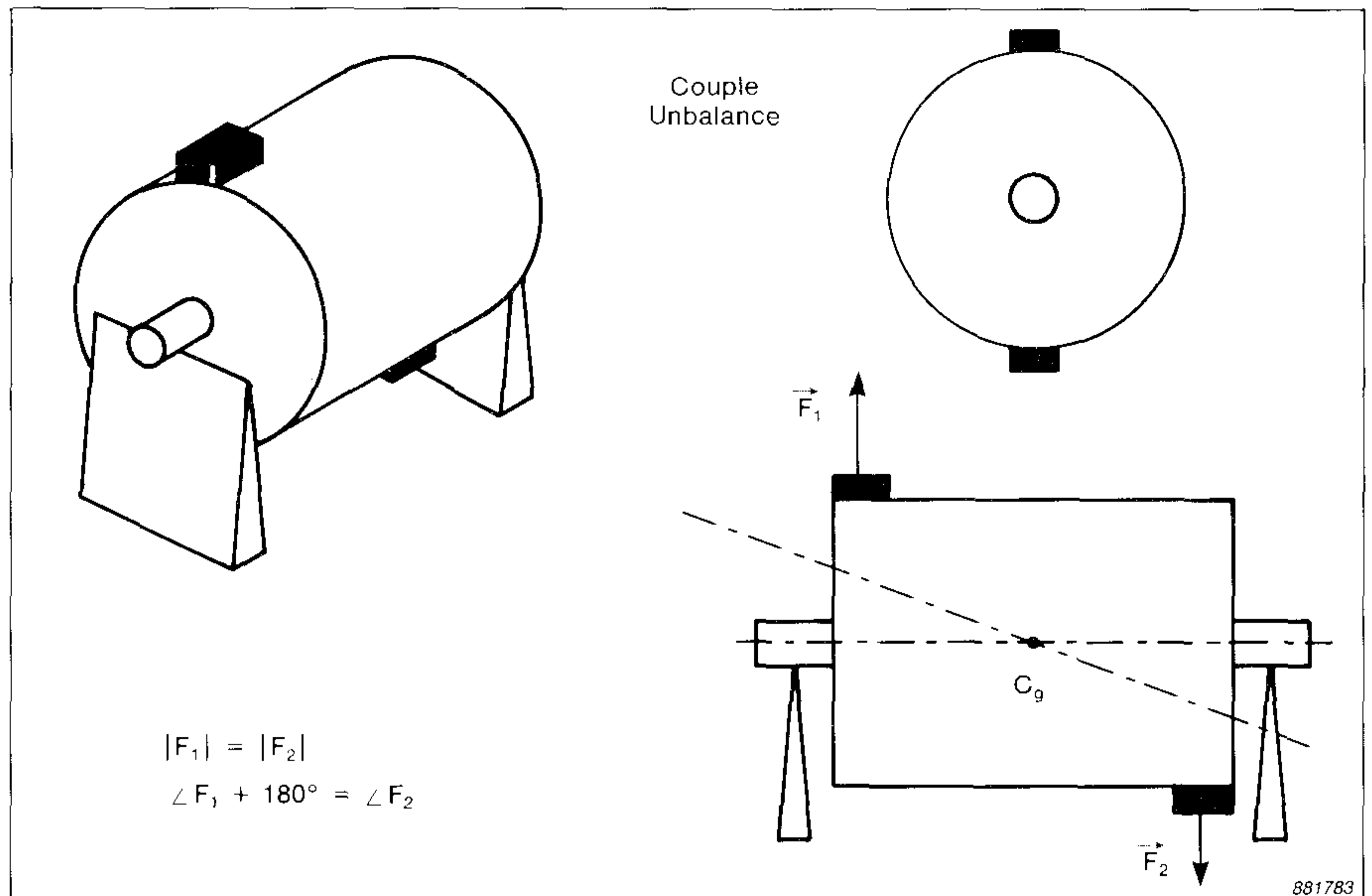

Fig. 2. Couple unbalance

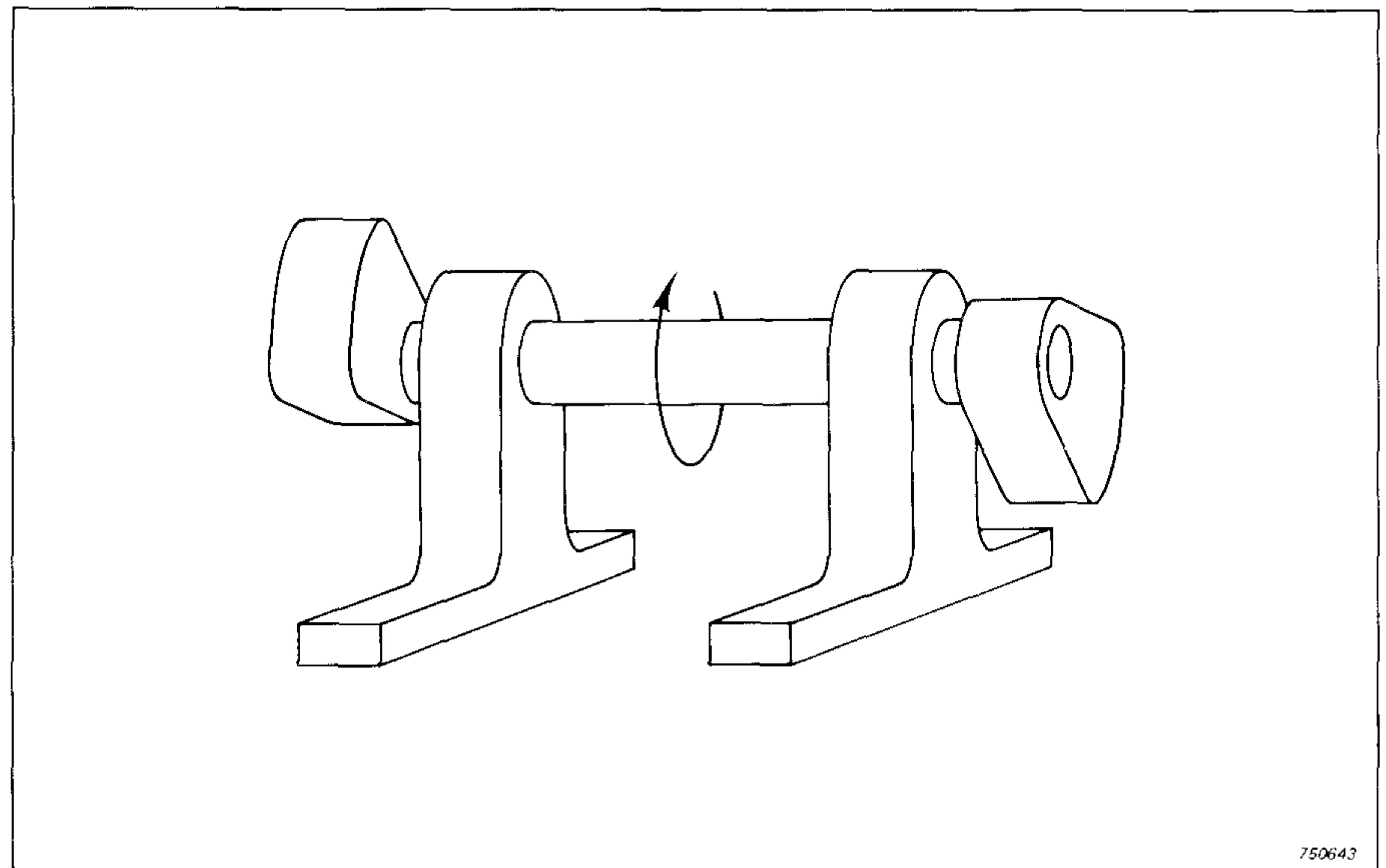

Fig. 3. Static balance, couple unbalance

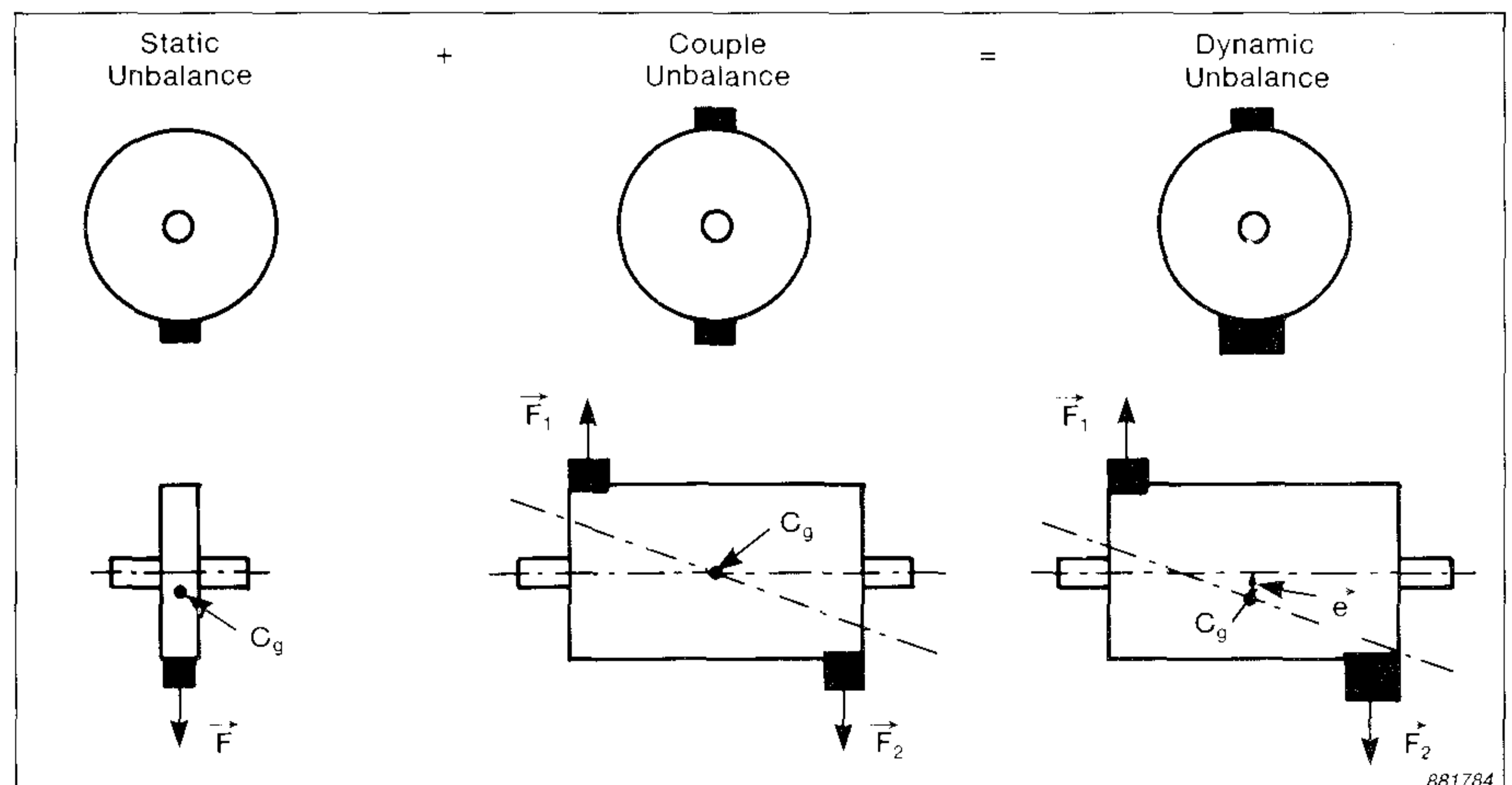

Fig. 4. Dynamic unbalance

Principle of Balancing

A rotor is balanced by placing a correction mass of a certain size in a position where it counteracts the unbalance in the rotor. The size and position of the correction mass must be determined.

The principle of performing field balancing is to make (usually temporary) alterations to the mass distribution of the rotor, by adding trial masses, and to measure the resulting phase and magnitude of bearing vibration. The effects of these trial corrections enable the amount and position of the required correction mass to be determined. The values are usually calculated with the aid of a pocket calculator.

Any fixed point on the bearing experiences the centrifugal force due to the unbalance, once per revolution of the rotor. Therefore in a frequency spectrum of the vibration signal, unbalance is seen as an increase in the vibration at the frequency of rotation.

The vibration due to the unbalance is measured by means of an accelerometer mounted on the bearing housing, see Fig. 5. The vibration signal is passed through a filter tuned to the rotational frequency of the rotor, so that only the component of the vibration at the rotational frequency is measured. The filtered signal is passed to a vibration meter, which displays the magnitude. The indicated vibration level is directly proportional to the force produced by the unbalanced mass.

The phase meter measures and displays the phase between the signal from the tachometer probe (the reference signal) and the filtered vibration signal. The angle displayed by the meter enables us to locate the angular position on the rotor of the unbalance, relative to the datum position.

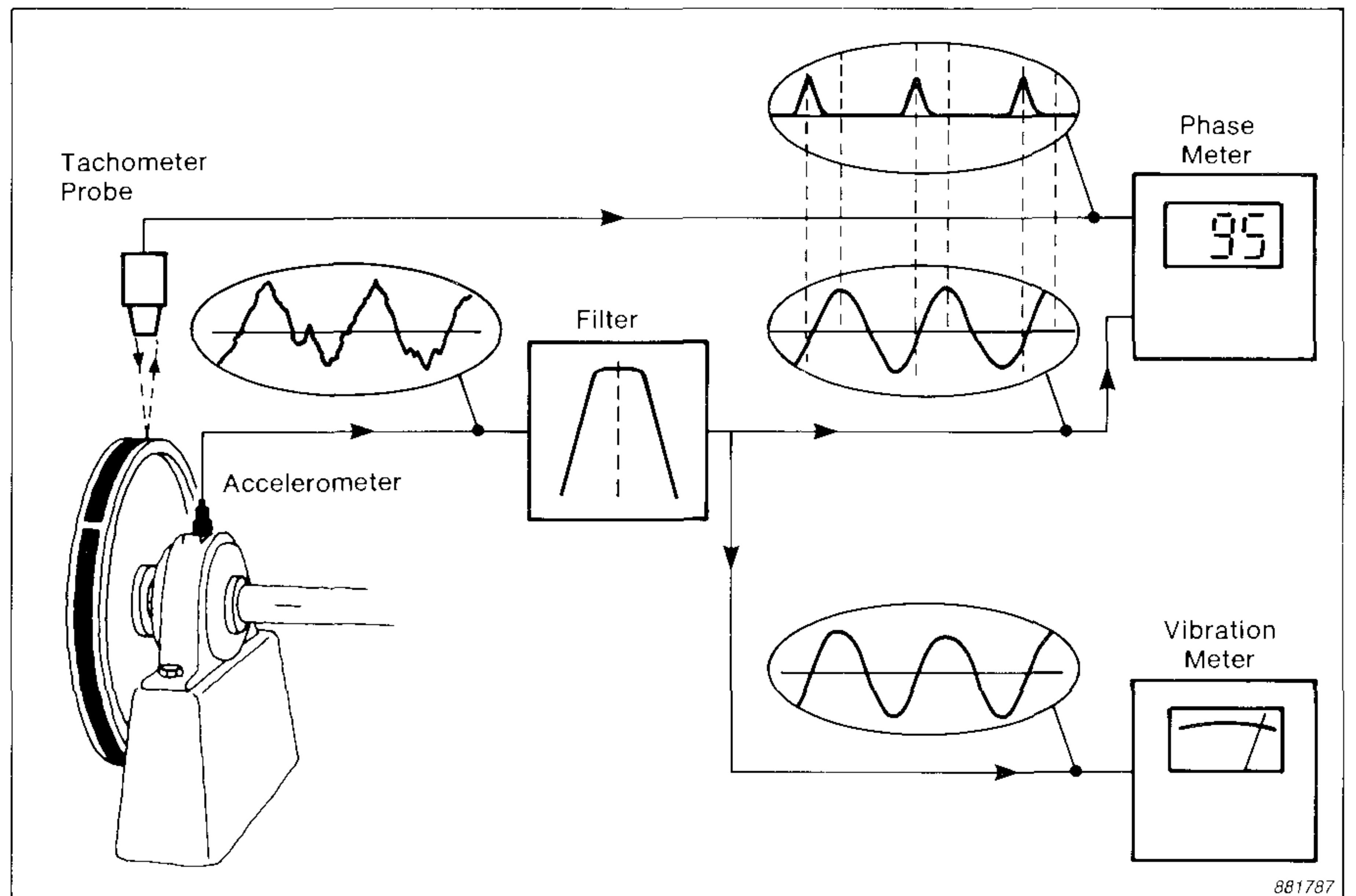

Fig. 5. The basic measurement chain

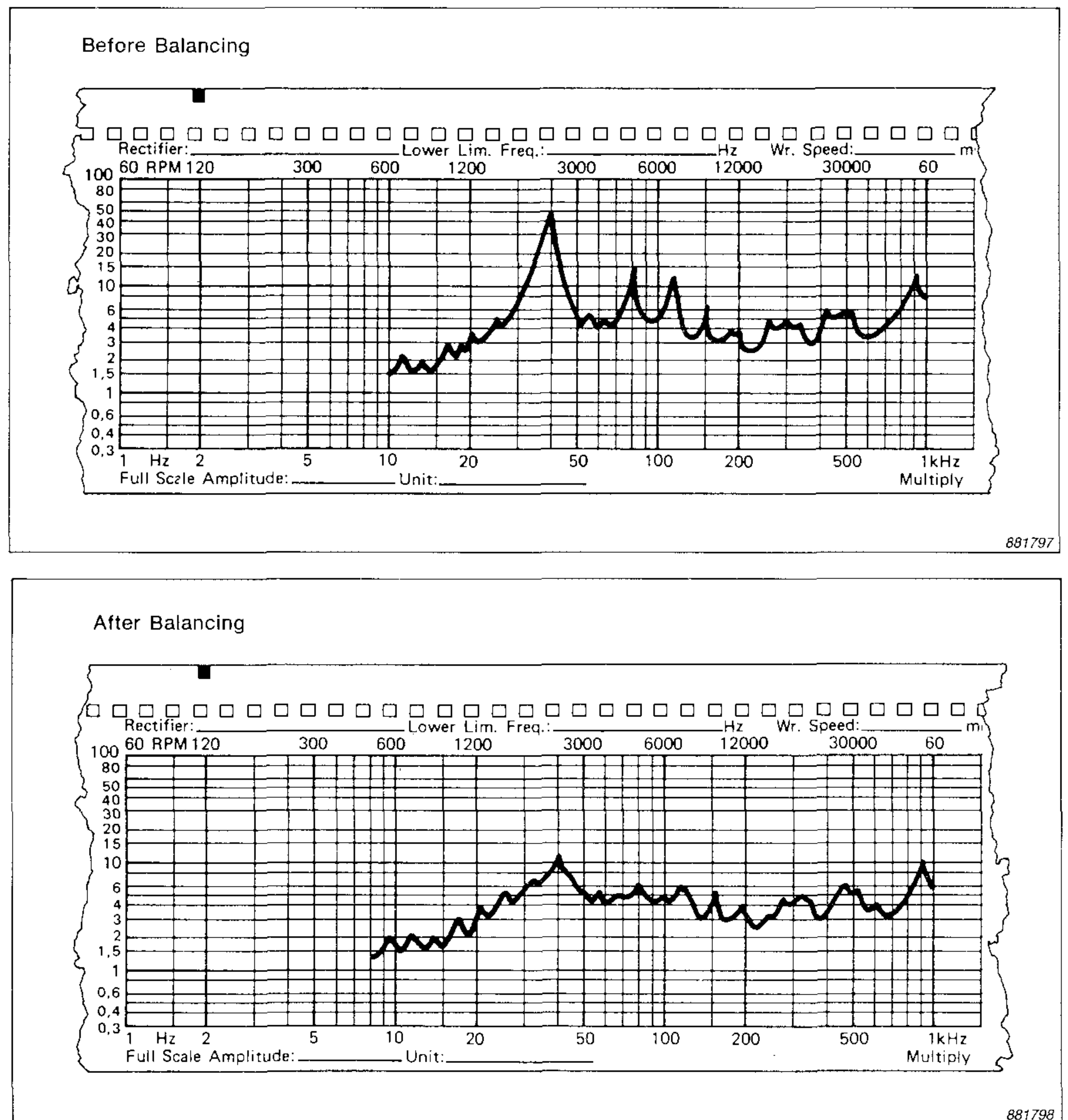

Fig. 6. Frequency spectra of the vibration signal, (upper) before balancing and (lower) after balancing

General Balancing Procedure

Performing a Frequency Analysis

Before an attempt is made at balancing, a frequency analysis should be carried out to see whether it is unbalance that is causing the excess vibration, or some other fault, such as mis-

alignment, or a bent shaft. If a rotor is unbalanced, there will be a peak in the vibration level at its rotational frequency and this peak will usually dominate the spectrum.

By performing a frequency analysis before and after balancing, the reduction in vibration level due to the balancing can also be clearly seen (see Fig. 6).

Selecting the Best Measurement Parameter

A frequency analysis of the vibration signal before balancing also guides us in the selection of the best parameter for measuring the vibration. The vibration can be measured in terms of acceleration, velocity, or displacement. Fig.7 shows the relationship between the three parameters as a function of frequency. The three curves have different slopes, but the peaks in the spectrum occur at the same frequencies in each case. The same information about the vibration levels is contained in each curve, but the way the information is presented differs considerably.

The parameter with the *flattest* curve, i.e. the most horizontally aligned spectrum, is usually selected for vibration measurement. This parameter requires the smallest dynamic range in the measuring instruments, so the signal-to-noise ratio is higher.

Experience has shown that velocity usually has the *flattest* curve, so it is the parameter most often selected. Use of acceleration levels tends to emphasize higher frequency components, so acceleration is chosen where low frequency noise is a problem. Displacement, on the other hand, tends to emphasize the lower frequency components and is therefore used to avoid high frequency noise.

Determining Balance Quality

Ideally a balanced machine would show no unbalance at all. In practice however, due to machining tolerances, perfect balance can never be achieved. For different types and sizes of machines, the level of vibration regarded as excessive varies considerably: for example, an acceptable vibration level in the crankshaft of a motorcar would probably destroy a record-player. It is important therefore to classify the rotor to be balanced according to the level of vibration that is acceptable.

Table 1 shows a Brüel & Kjær Unbalance Nomogram, based on ISO Standard 1940. The Nomogram lists Quality Grades and some typical examples of each grade. Once the grade has been decided, the maximum allowable residual unbalance can be determined, if the rotor service speed is known. The value obtained is the maximum allowable level of specific unbalance (in g mm/kg) after balancing.

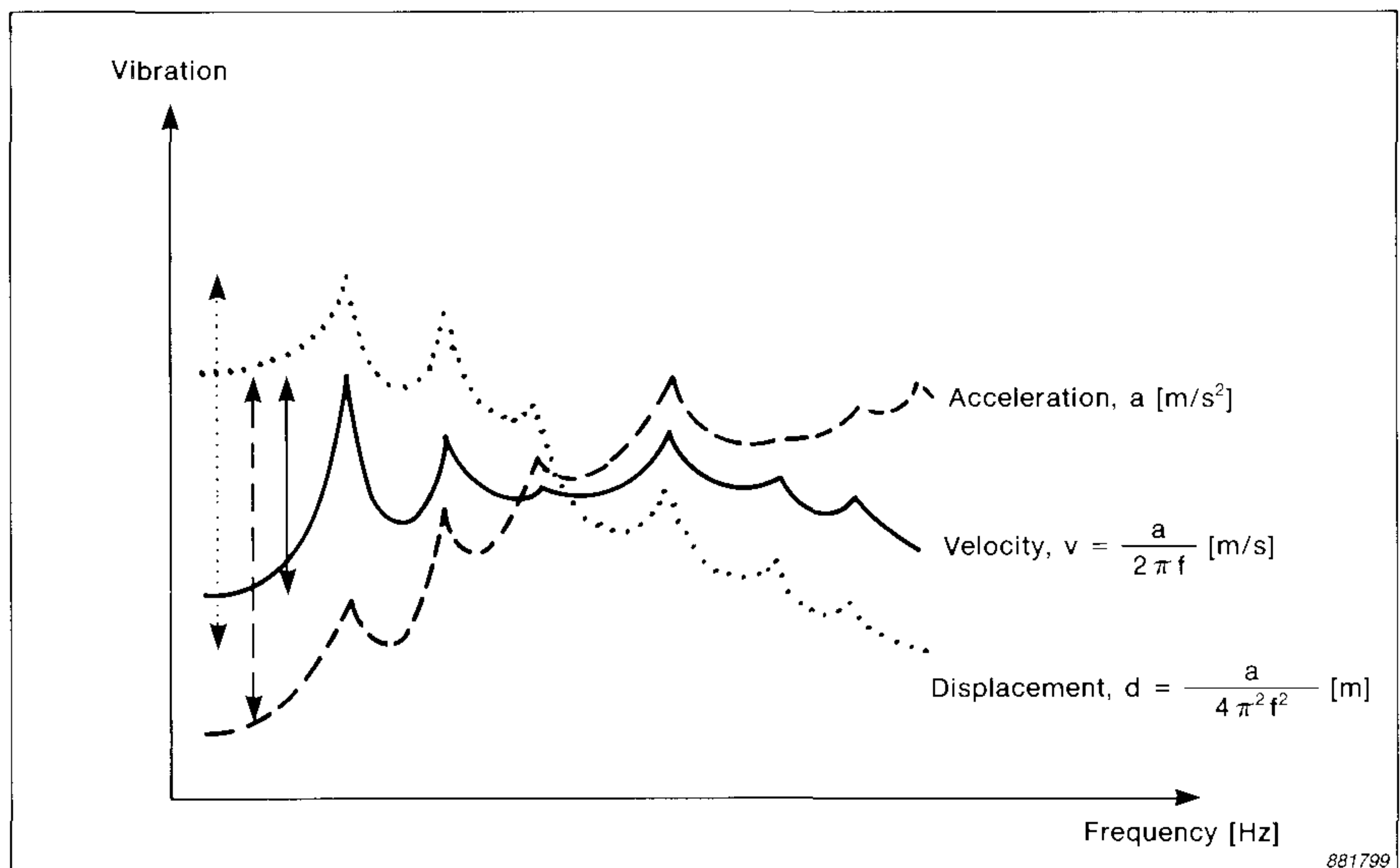

Fig. 7. Frequency spectra produced using three different measurement parameters: acceleration, velocity and displacement. The signal range for each parameter is shown

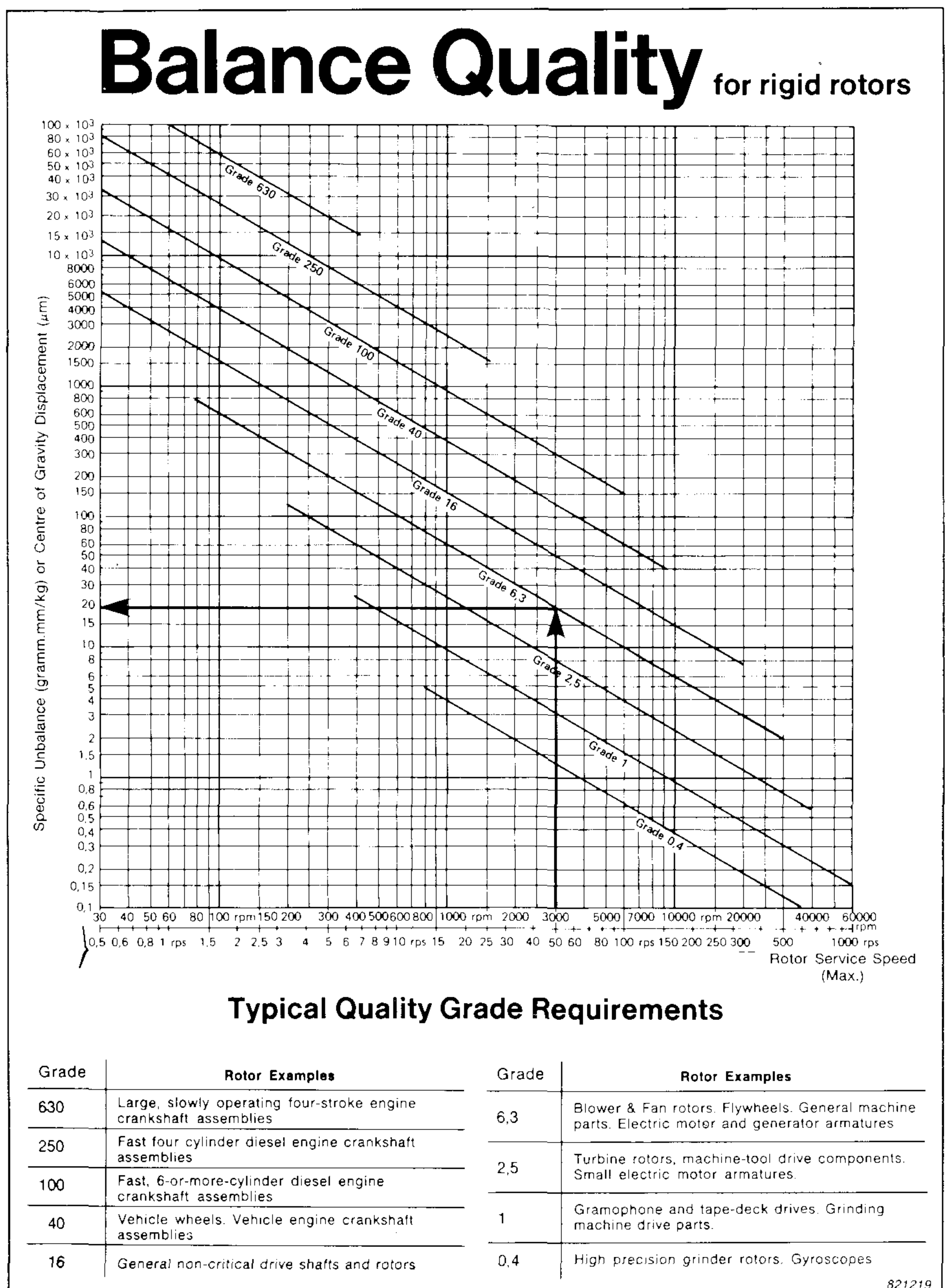

Table 1. Specific Unbalance (gmm/kg) as a function of Balance Quality Grade and Rotor Maximum Service Speed

The calculation of the maximum allowable residual specific unbalance assumes that the mass of the rotor is evenly distributed about the centre of gravity. If the mass of the rotor is unevenly distributed, the calculations are a little more complicated.

In a perfectly balanced rotor, equal forces act on both ends of the rotor when it rotates. If the rotor is shaped as in Fig. 8, however, the forces at each end will be equal, but the allowable residual specific unbalance will be different for each bearing. The position of the centre of gravity divides the rotor in the ratio $1/3 : 2/3$. The sum of the moments about the centre of gravity must be zero. Therefore the residual specific unbalance at bearing A is $2/3$ of the total residual specific unbalance, while at bearing B it is $1/3$ of the total.

Selection of Trial Masses

The specific unbalance is used to calculate the size of trial masses, which are used during balancing to make temporary alterations to the mass distribution of the rotor, to determine the relationship between the specific unbalance and the bearing vibrations.

To estimate the value of a suitable trial mass, the mass of the rotor in kg and the radius in mm at which the corrections are to be made must be determined. The Maximum Residual Mass M_{MR} , in grammes, is given by:

$$M_{MR} = \frac{S.U. \times M_R}{R_C}$$

where

$S.U.$ = Specific Unbalance required (in g mm/kg)

M_R = Rotor Mass (kg)

R_C = Correction Radius (mm)

A suitable trial mass is five to ten times the value of the Maximum Residual Mass.

Single-Plane (Static) Balancing

Having made a frequency analysis of the vibration and calculated the value of a suitable trial mass, the procedure for single-plane balancing is as follows:

1. Mount an accelerometer and tachometer probe and connect them to the instruments.
2. Run the machine at its normal operating speed*.

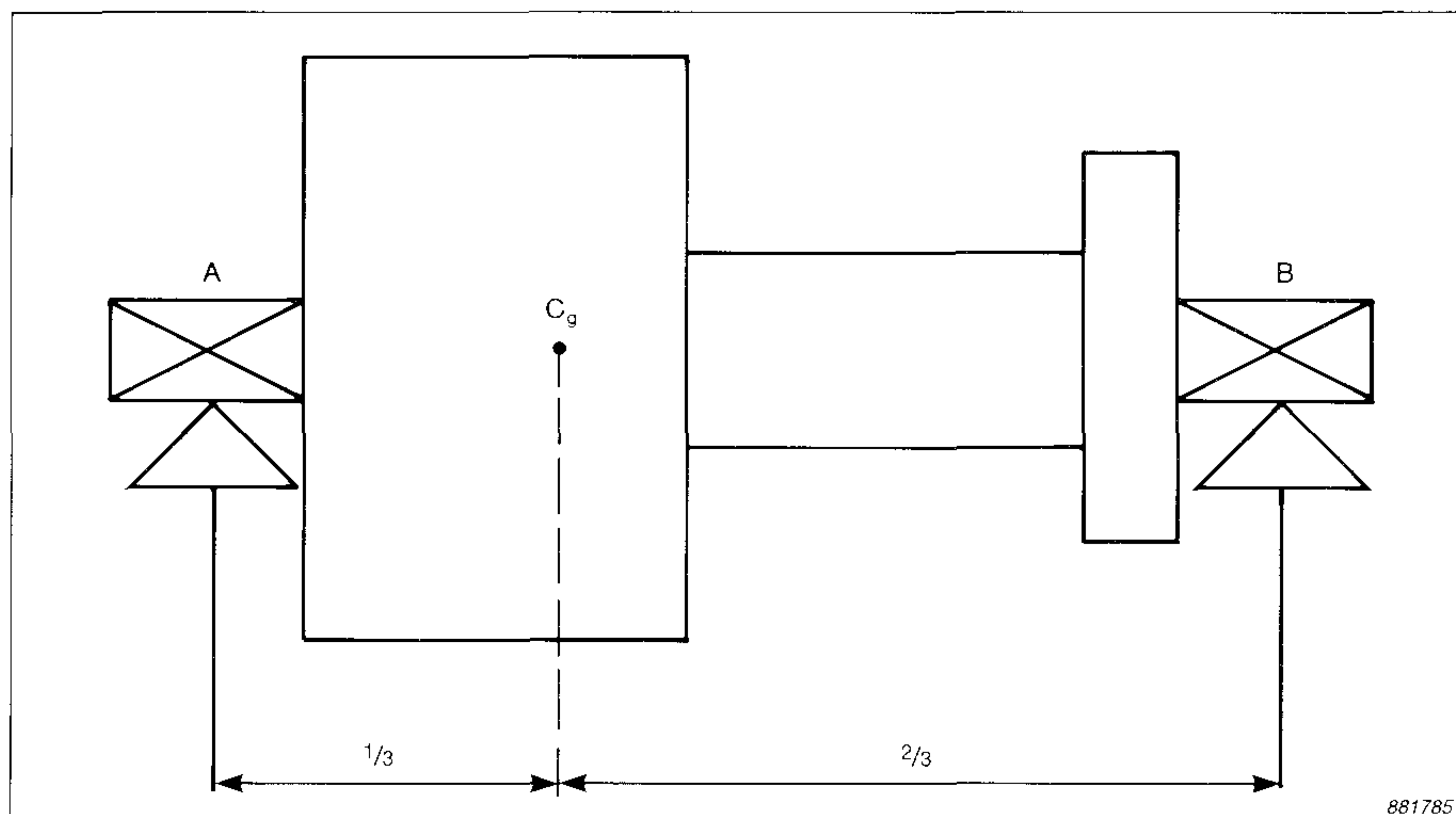

Fig. 8. A rotor with unevenly distributed mass

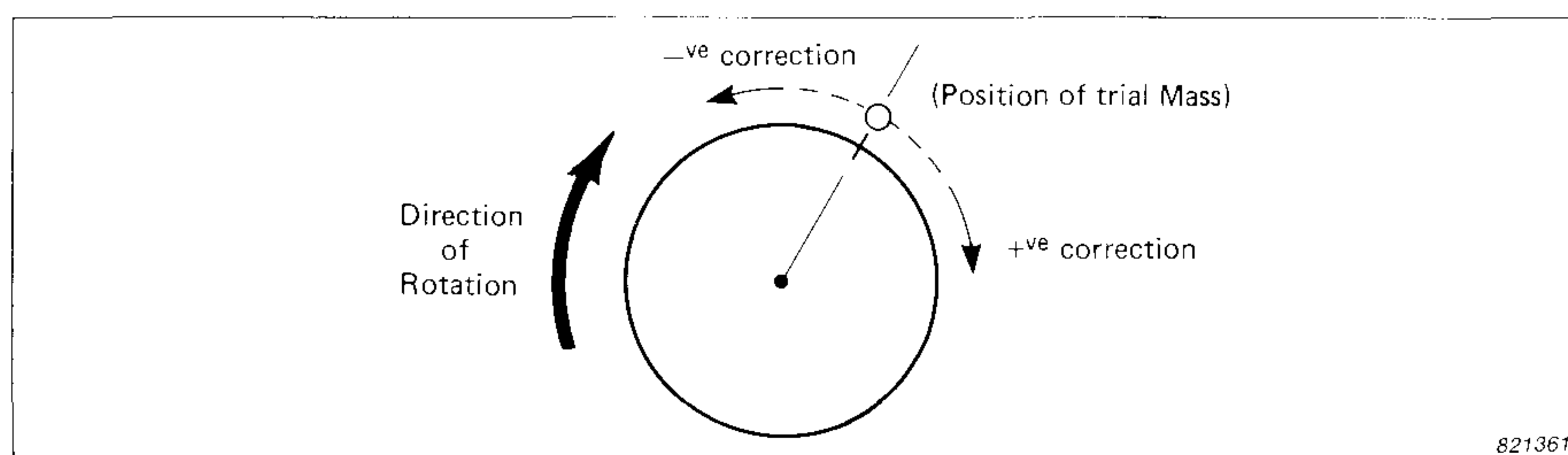

Fig. 9. Determining the position of the correction mass

3. Measure and record the vibration level and phase angle.
4. Stop the machine and mount a trial mass of suitable size arbitrarily in the correction circle, i.e. the plane where the correction is to be made. *Mark the position of the trial mass.*
5. Start up the machine and measure and record the new vibration level and phase angle.
6. Stop the machine and remove the trial mass.
7. Calculate the values of the correction mass and angle required, using one of the methods detailed in the section on *Calculation Methods*.
8. Mount the correction mass at the position indicated by the correction angle. A positive correction angle indicates that the angle should be measured in the direction of rotation. For a negative correction angle, measure against the direction of rotation, see Fig. 9. The correction mass should be mounted at the same radius as the trial mass.
9. Start up the machine again and measure the residual unbalance. If

care has been taken with the balancing procedure and proper balancing equipment, such as that described in the section on *Instrumentation*, has been used, the level of residual vibration measured should be small and it should not be necessary to repeat the balancing procedure.

Two-Plane (Dynamic) Balancing

The procedure for two-plane balancing is very similar to that for single-plane balancing. In this case, however, two accelerometers must be used, since measurements in two planes are required. Unbalance in one plane affects the other; this is known as the cross effect. Before balancing, a frequency analysis of both planes is made.

The steps involved in two-plane balancing are as follows:

1. Mount the accelerometers and tachometer probe and connect them to the instruments.
2. Run the machine at its normal operating speed*.

* It is preferable, but not in fact necessary to balance a rotor at its service speed. See the section *Special Balancing Cases* for details on balancing at less than service speed.

3. Measure and record the vibration level and phase angle for each plane in turn.
4. Stop the machine and mount a trial mass of suitable size arbitrarily in plane 1, *marking its position*.
5. Start up the machine and measure and record the new vibration level and phase angle, for each plane in turn.
6. Stop the machine and remove the trial mass.
7. Mount a trial mass of suitable size in plane 2 (the trial mass used in plane 1 can be used again) and *mark its position*.
8. Start the machine again and measure the vibration level and phase angle once more, for each plane in turn.
9. Stop the machine and remove the trial mass.
10. Calculate the values of the correction masses and angles required, using one of the methods detailed in the section on *Calculation Methods*.
11. Mount the correction masses at the positions indicated by the correction angles and at the same radius as the trial masses.
12. Start up the machine again and measure the amount of residual unbalance in the rotor, to see how successful the balancing job has been.

Measurement Check

Despite care in selection of a trial mass, it can happen that the trial mass does not give suitable results for the balancing calculations. Before using the effects of the trial mass to calculate the correction mass, it is very important to check that the results are suitable.

Four possibilities can arise, as shown in Table 2, where:

$\Delta\phi$ is the difference between the phase measured before and after the trial mass was mounted.

ΔV is the difference between the vibration level measured before and after the trial mass was mounted.

	$\Delta V < 25\%$	$\Delta V > 25\%$
$\Delta\phi < 25^\circ$	Increase trial mass	Move trial mass
$\Delta\phi > 25^\circ$	Proceed	Proceed

T01939GB0

Table 2. Checking the measurements

If the change in the phase $\Delta\phi$ is smaller than 25° , the size of the trial mass must be increased or the trial mass must be moved.

If the change in the phase angle $\Delta\phi$ is greater than 25° , the measured val-

ues can be used to calculate the correction mass and angle.

Balancing Report

It is a good idea to keep a record of each balancing job so that the measurements can be repeated with the same instrument settings if necessary. The Brüel & Kjær Balancing Report, shown in Fig. 10, provides a convenient method of recording the necessary details. The numbering system used in the report facilitates the input of data, when using a calculator to determine the correction values (see the section on *Calculation Methods*). A copy of a

BALANCING REPORT						
Subject: <u>Machine N° 1</u>						
Vibration Meter Setting, Range: <u>100</u>						
Lower Limiting Frequency (LLF): <u>10 Hz</u> Meter Function: <u>Displacement</u>						
Filter Setting, Bandwidth: <u>23%</u> Frequency: <u>50 Hz</u>						
	Measuring plane 1			Measuring plane 2		
	Amplitude	Phase		Amplitude	Phase	
Initial unbalance	1 81 A ₁₀	2 222 ∠ ₁₀	(7)	67 A ₂₀	(8) 60 ∠ ₂₀	
Trial mass 1 in correction plane 1	3 95 A ₁₁	4 115 ∠ ₁₁	(9)	69 A ₂₁	(10) 63 ∠ ₂₁	
Trial mass 2 in correction plane 2	(5) 79 A ₁₂	(6) 218 ∠ ₁₂	(11)	72 A ₂₂	(12) 120 ∠ ₂₂	
	Trial mass 1			Trial mass 2		
	13 10			(14) 20		
	Correction plane 1			Correction plane 2		
	Mass	Angle		Mass	Angle	
Corrections	15 6	-42,8	(16)	19,9	64,2	
	Measuring plane 1			Measuring plane 2		
	Amplitude	Phase		Amplitude	Phase	
Residual unbalance	6,7 A ₁₀	60 ∠ ₁₀		5,8 A ₂₀	— ∠ ₂₀	
Remarks: _____						
Date: _____ Sign: <u>ÅSN</u>						
Brüel & Kjær, Nærum Hovedgade 18, DK-2850 Nærum, Denmark, Telefon: (02)800500						
881788						

Fig. 10. A Brüel & Kjær Balancing Report showing data recorded during a balancing job

balancing report can be found in Appendix 3. This can be photocopied and filled in by the user during the balancing operation.

Procedure for Balancing Overhanging Rotors

Figs. 11, 12 and 13 show typical examples of overhung rotors. If the length of the rotor is approximately $\frac{1}{7}$ to $\frac{1}{10}$ of its diameter (Fig. 11) then single-plane balancing can be performed, making measurements at the bearing which is most influenced by the trial mass. For other cases, however, it is necessary to use two correction planes with one of the following methods:

1. Use a single-plane balancing procedure twice:

Firstly, carry out the static balancing procedure with the trial mass divided into two equal masses and mounted as shown in Fig. 12 a. Measure on the bearing which is most influenced by the trial mass. The calculated correction mass should also be divided into two equal masses.

Secondly, carry out the static balancing procedure again, this time with the trial masses mounted as a couple, i.e. the two trial masses mounted in the two correction planes, but 180° from one another, as in Fig. 12 b. The forces around the centre of gravity of the rotor should be equal and in opposite directions. The calculated correction mass should also be made as a couple.

Note that the "trial mass" required in the calculator program will be the sum of the two trial masses used.

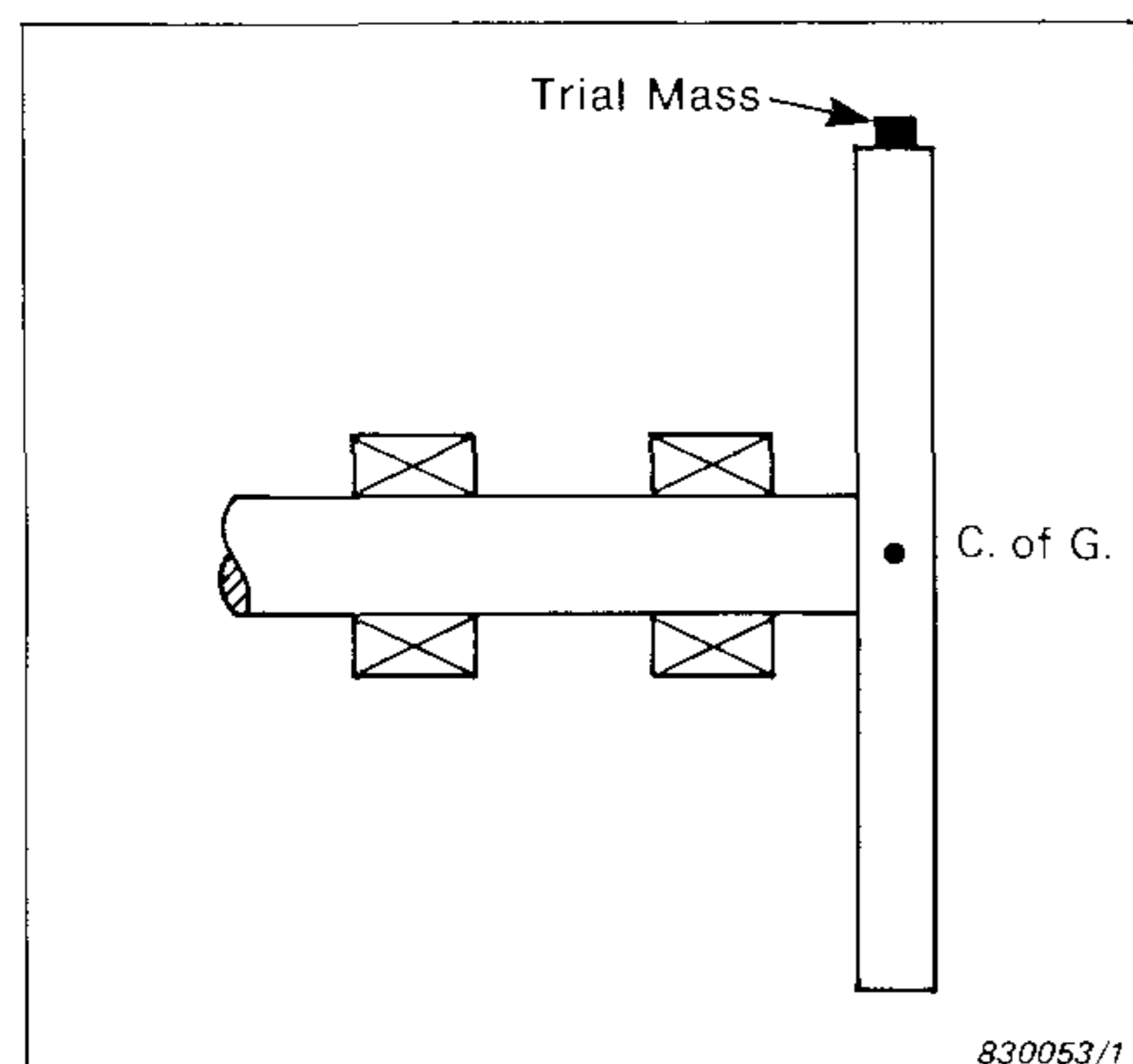

Fig. 11. Overhung rotor balanced using a single-plane procedure

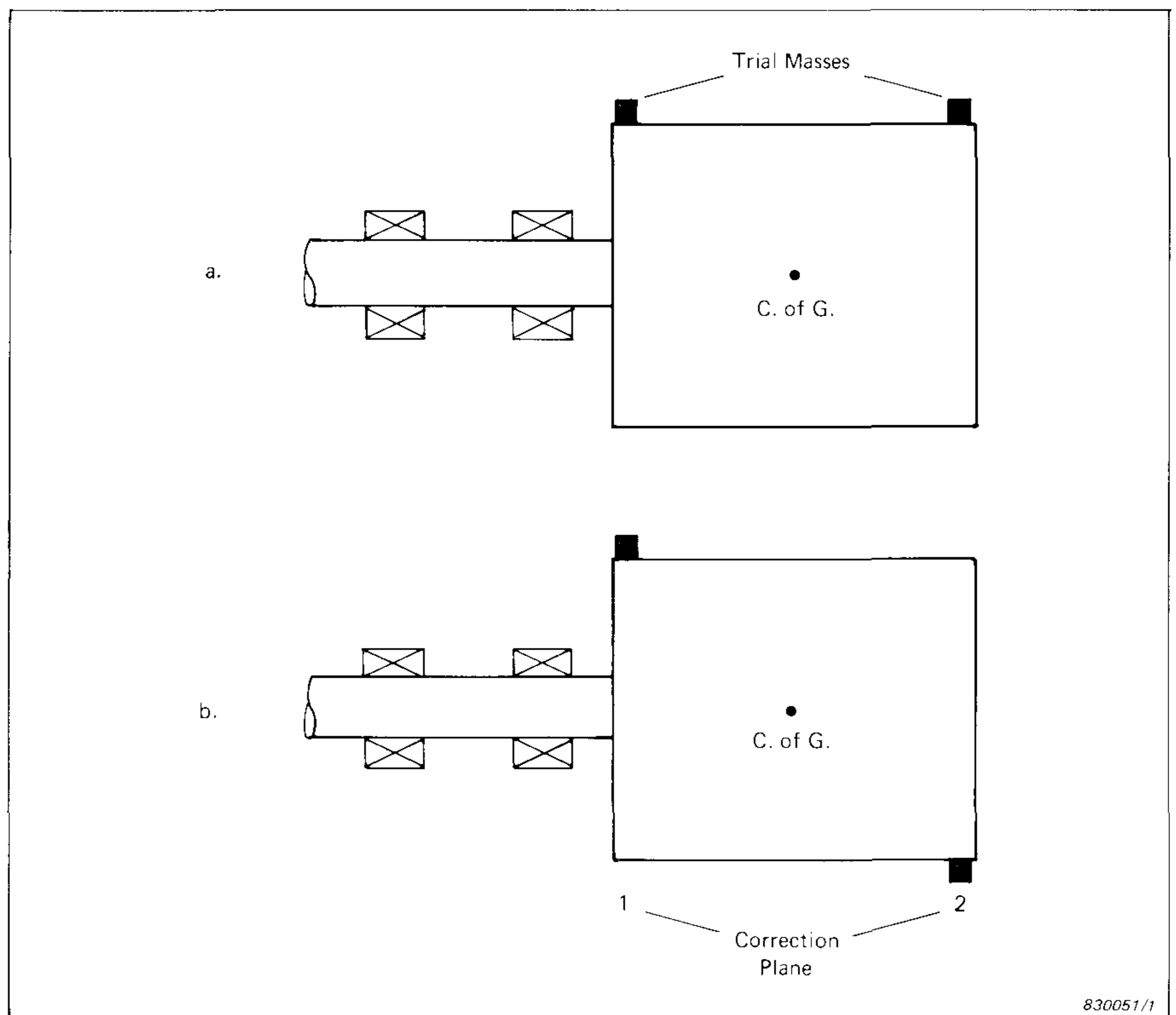

Fig. 12. Overhung rotor balanced using a single-plane procedure twice

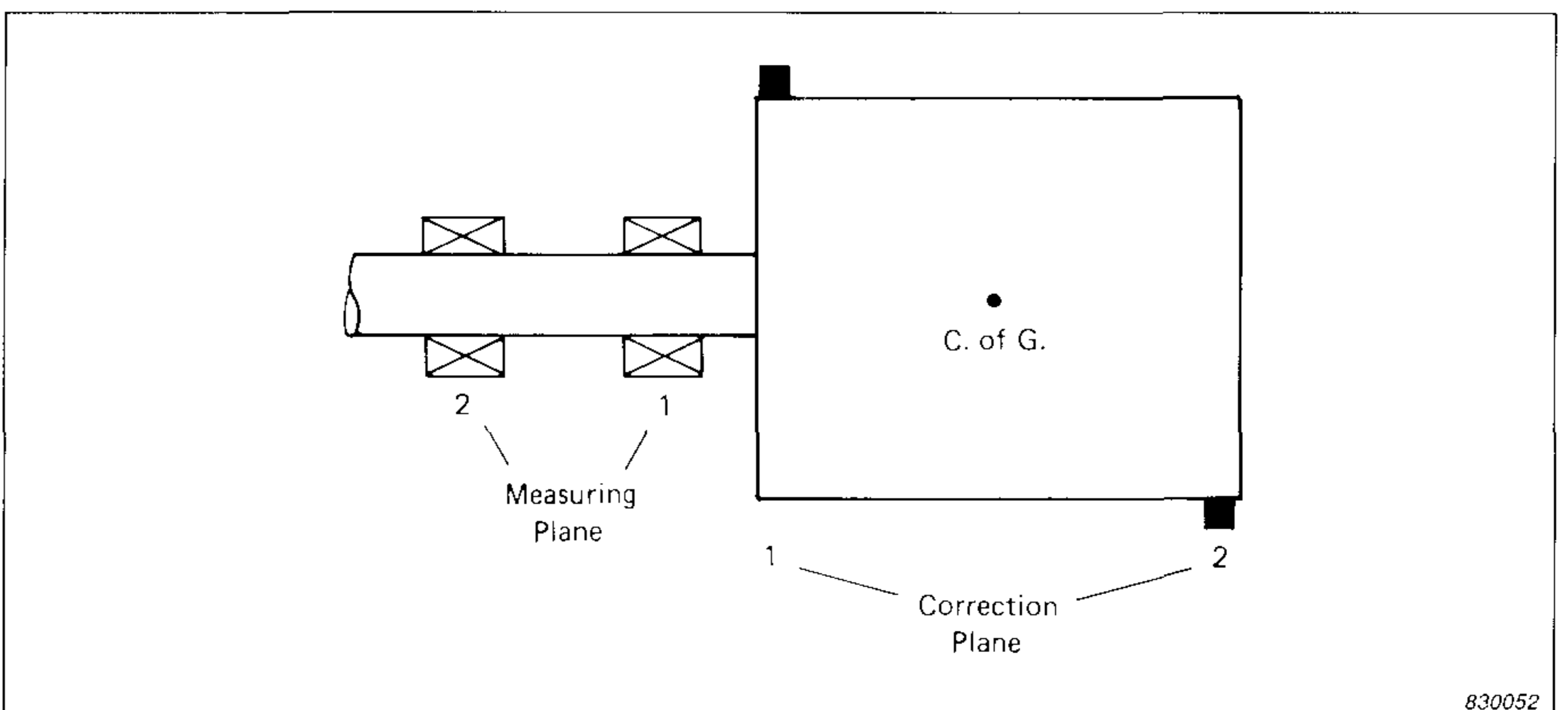

Fig. 13. Overhung rotor balanced using a two-plane procedure

2. Perform a two-plane balancing procedure using the measuring planes and the correction planes as indicated in Fig. 13.

Note that the trial masses can be mounted as in the normal two-plane balancing procedure, i.e. arbitrarily on the correction circle.

Special Balancing Cases

Balancing at Less than Service Speed

It is preferable, but not in fact necessary to balance a rotor at its service

speed. In many cases it is not possible to run a rotor at full speed during the balancing operation.

The only consideration necessary when balancing at less than the service speed is the grade of Balance Quality required. If it is stipulated that a rotor must be balanced to a certain quality grade then, when balancing the same rotor at less than the service speed, the balance quality must be increased correspondingly. Using the example shown earlier in Table 1, where a Grade 6,3 is required at 3000 RPM, then if the rotor is to be balanced at only 500 RPM it must be balanced to a Grade 1.

Correction Mass and Correction Radius

It is sometimes impossible to mount the correction mass at the same radius as the trial mass, because of the structure of the rotor, see Fig. 14.

In this case, to correct the unbalance, we use the relation:

$$\vec{e} = \frac{m \vec{r}}{M}$$

where

$$\begin{aligned} \vec{e} &= \text{specific unbalance} \\ m &= \text{unbalance mass} \\ \vec{r} &= \text{correction radius} \\ M &= \text{rotor mass.} \end{aligned}$$

This can also be written:

$$\vec{e} M = m \vec{r}$$

Therefore,

$$\vec{e} M = m \vec{r} = m_1 \vec{r}_1 = m_2 \vec{r}_2 = \dots$$

So, if the radius, \vec{r}_2 , at which the correction mass is to be mounted, is different from the radius, \vec{r}_1 , at which the trial mass was mounted, we simply change the value of the correction mass, m_2 , so that the product $m \vec{r}$ remains constant, i.e. so that:

$$m_2 \vec{r}_2 = m_1 \vec{r}_1$$

Checking Residual Unbalance

After a balancing job has been completed the residual unbalance should be determined. This can be done directly using proper balancing equipment, such as that described earlier in this Application Note. However, in a situation where no adequate equipment is available, a procedure described in ISO Standard 1940 may be used, as follows:

1. Mark out equal intervals of for example 45° on the rotor, see Fig. 15.
2. Mount a trial mass at the 0° position. Rotate the rotor at its service speed and measure the vibration amplitude. Record the measurement result in a table, see Fig. 15.
3. Move the trial mass to the 45° position, measure the vibration and record the result in the table.
4. Continue moving the mass to each of the marked positions in turn, and tabulate the results.
5. Plot the vibration amplitude against the position of the trial mass as shown in Fig. 15. A useful measurement result is obtained if the curve is approximately sinusoidal.

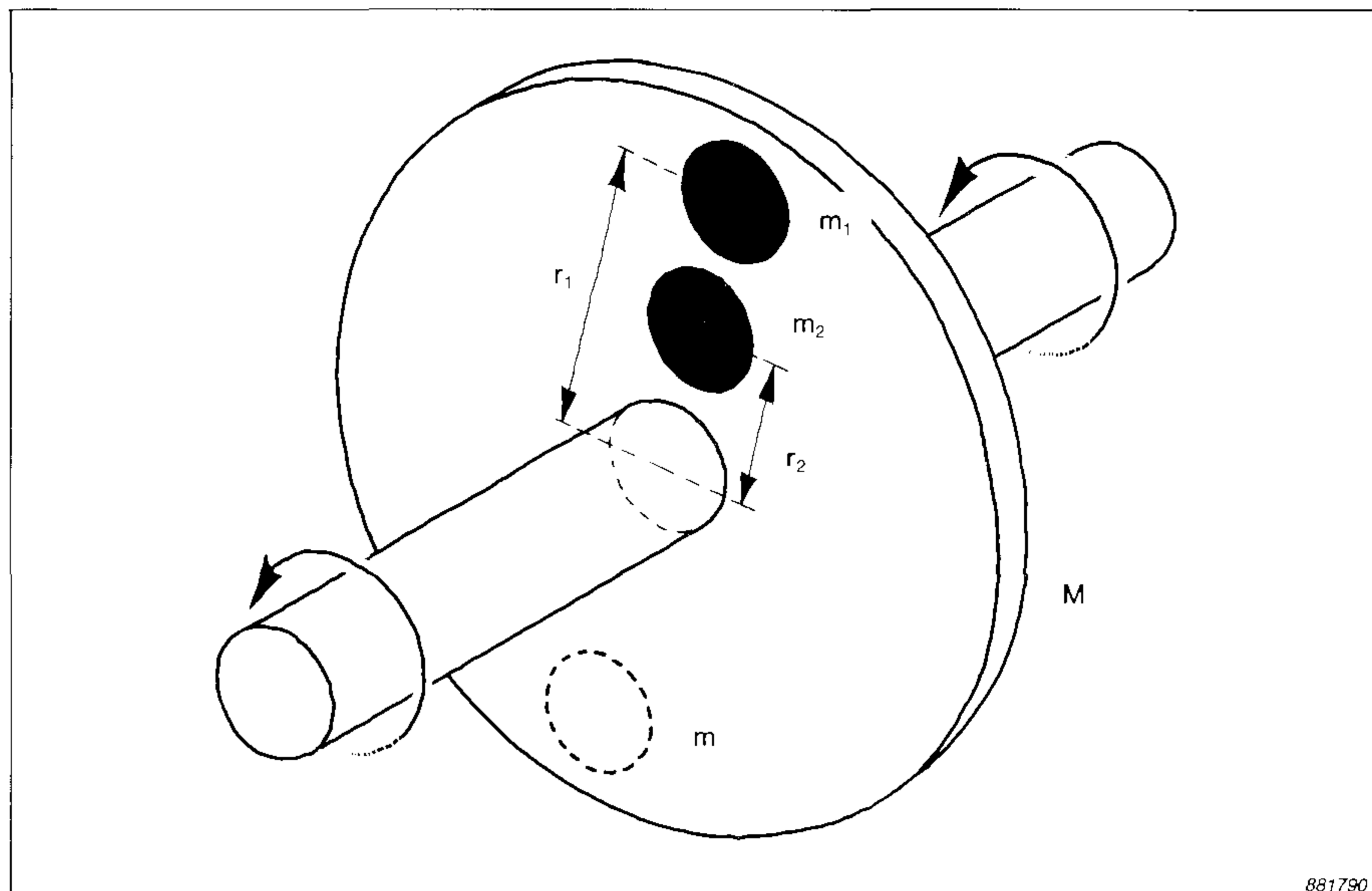

Fig. 14. Mounting the correction mass at a radius different from the radius at which the trial mass was mounted

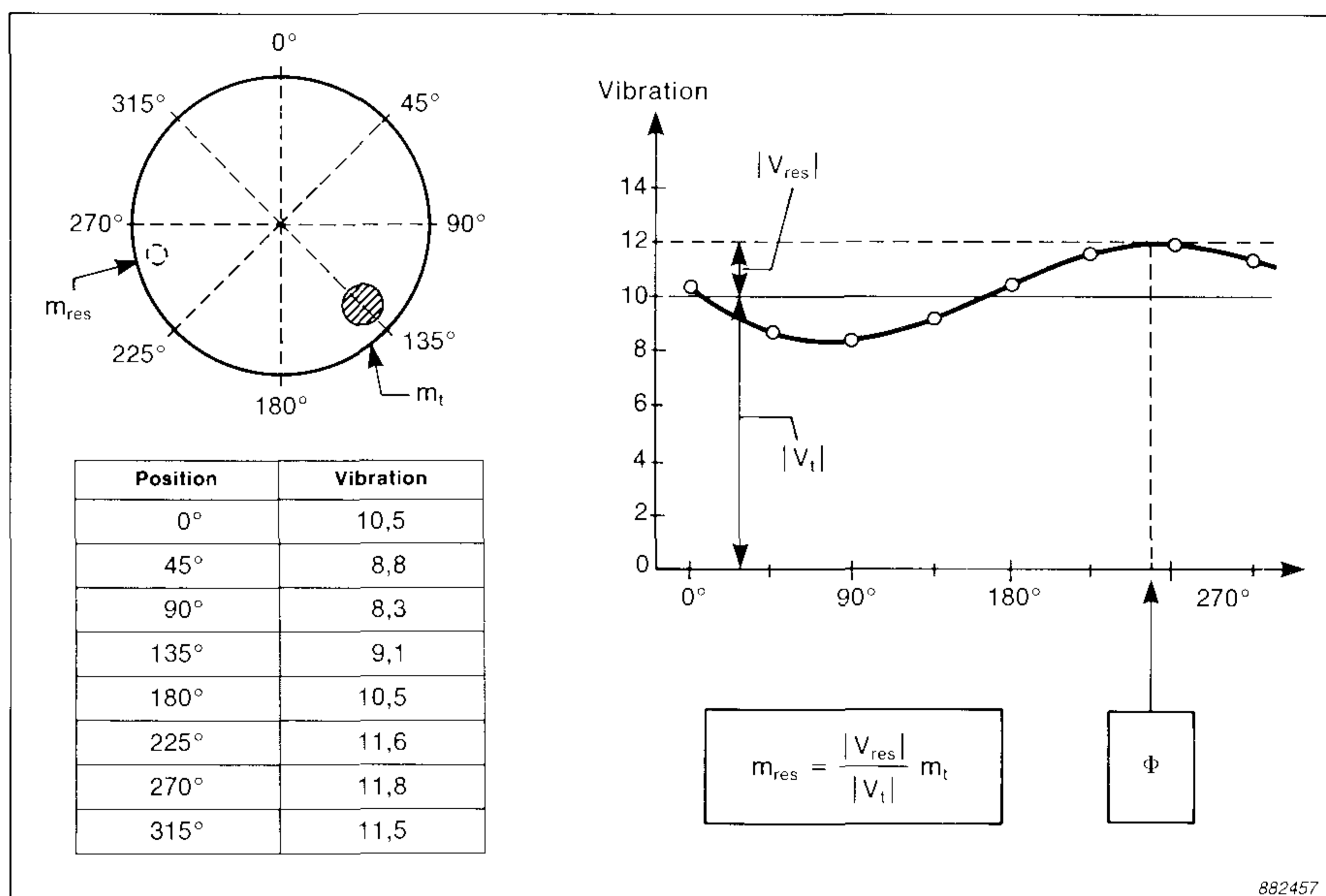

Fig. 15. Graphical method of checking for residual unbalance using just a vibration meter

6. Draw a line half-way between the highest and lowest points of the sine curve. The distance between this line and the highest point on the sine curve represents the magnitude of the unbalance (V_{res}), and the distance to the zero line represents the magnitude of the trial mass (V_t). The magnitude of the residual unbalance mass (M_{res}) can then be calculated from:
7. The position of the residual unbalance mass (Φ) is found by drawing a vertical line from the highest point on the sine curve, and reading the angle on the horizontal axis.

Since the position of the residual unbalance mass is found graphically it is clearly seen that this procedure can be used if only a vibration meter is available for the measurement. The disadvantage of the procedure is that it takes much longer time to perform a balancing job compared with a direct measurement of vibration and phase.

$$M_{res} = \frac{|V_{res}|}{|V_t|} \times M_T$$

Calculation Methods

When suitable test results have been obtained, the next step is to calculate the values of the correction mass(es) and angle(s) required. There are two methods of finding the necessary data:

Calculator and Balancing Program WW9021

The easiest method of calculation is to use the Brüel & Kjær balancing program WW9021. The program runs on the Hewlett-Packard HP41 CV and CX calculators (and discontinued C version, with Memory Modules fitted). Using this method, even an inexperienced operator can soon learn to perform the whole calculation in about two minutes. The program provides the calculations for both single-plane and two-plane balancing. A calculator overlay, supplied with the program, displays clearly the keys used with the program and their functions.

The program is supplied on five magnetic cards each with two tracks. A sixth card is provided for storing data using the SAVE function.

The calculation procedure is as follows:

1. Load the calculator with the WW9021 program, see the WW9021 Instruction Manual for loading instructions.
2. Select [1-PLANE] or [2-PLANE] balancing.
3. Key in the data as prompted by the calculator display, e.g. A_{10} = amplitude measured in plane 1 with no trial mass; \angle_{21} = phase angle measured in plane 2 with trial mass mounted in plane 1. The order in which the items of data are requested follows the numbering system in the Brüel & Kjær Balancing Report. After each value has been keyed in, [DATA ENTER] is pressed.
4. When all the entries have been made, the calculator carries out a set of calculations for up to 30 seconds and then a "beep" is sounded.
5. The calculated correction masses and angles are then displayed repeatedly, for a few seconds at a time, until the calculator is switched off.

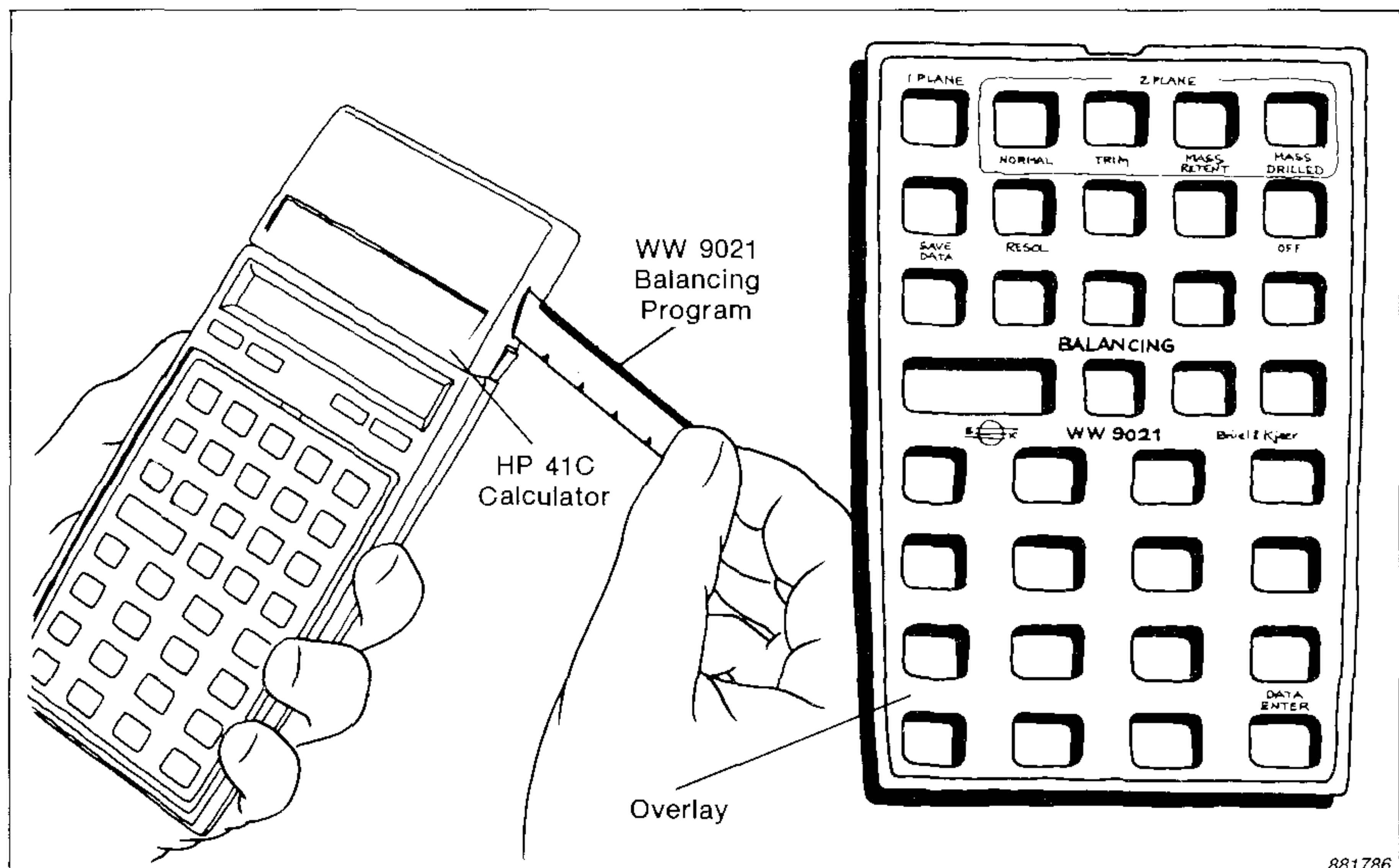

Fig. 16. Balancing Program WW9021, for use with the HP41CV and CX Programmable Calculators

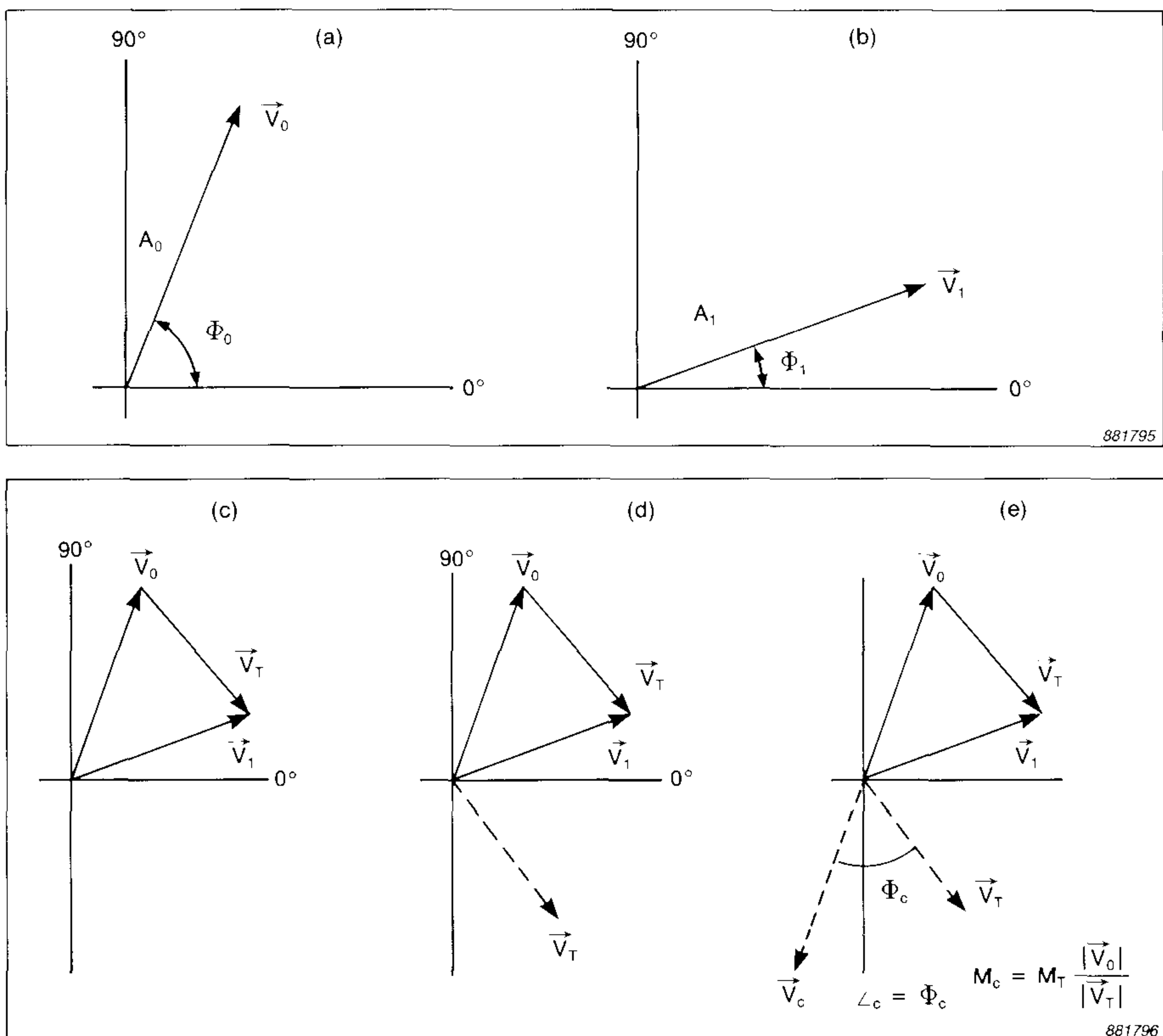

Fig. 17. Vectorial representation of the vibration levels: (a & b) measured values, (c, d & e) calculated values

Other functions of the WW9021 program allow for cases where trial corrections are permanent, e.g. where trial masses are welded on, or material is drilled from the rotor; see the WW9021 Instruction Manual for details.

The [RESOL] facility enables correction masses to be resolved into separate components, where corrections

can only be made at certain permitted locations; see the example at the end of this section.

Vector Diagram Calculations

(a) Single-Plane Balancing

The values of the correction mass and angle can be determined by representing the measurements vectorially, as shown in Fig.17:

1. A vector \vec{V}_O is drawn representing the initial unbalance. The length of \vec{V}_O is equal to the vibration amplitude and its direction is given by the phase angle.
2. Another vector \vec{V}_I is drawn representing the amplitude and phase measured with the trial mass mounted.
3. The tips of vectors \vec{V}_O and \vec{V}_I are joined by means of a third vector \vec{V}_T , which is marked so that it indicates the \vec{V}_O to \vec{V}_I direction, as shown. This vector represents the effect of the trial mass alone.
4. A vector is drawn parallel to the vector \vec{V}_T , with the same amplitude and direction, but starting at the origin. This vector is also called \vec{V}_T .
5. The vector \vec{V}_O is continued through the origin, in the opposite direction to \vec{V}_O . This vector is called \vec{V}_{COMP} and it represents the position and magnitude of the mass required to counteract the original unbalance.
6. If we assume that the amplitude of the vibration is proportional to the unbalance mass, we get the relation:

$$\frac{M_T}{\vec{V}_T} = \frac{M_{COMP}}{\vec{V}_{COMP}} = \frac{M_O}{\vec{V}_O}$$

$$\Rightarrow M_{COMP} = \frac{|\vec{V}_O|}{|\vec{V}_T|} \times M_T$$

This expression enables us to find the value of M_{COMP} , the compensating mass.

7. The position of the mass relative to the position of the trial mass can be determined from the vector diagram using a protractor, or can be found from the expression:

$$\angle_{COMP} = -\angle_T + \angle_O + 180^\circ$$

The angle calculated is measured from the position marked on the

* Strictly speaking this is a *phasor* and not a *vector*, since we are dealing with a "vector" in the complex plane, with real and imaginary components. In the world of balancing, however, the convention is to refer to the graphic representation of the unbalance as a "vector diagram", and not a "phasor diagram". The use of terms such as "unbalance vector" conforms to ISO standard 1925 on balancing.

rotor indicating the point where the trial mass was mounted. If it is a positive angle it is measured in the direction of rotation. A negative angle is measured in the opposite sense.

Example One, in Appendix 1 is a worked example of the use of this method for calculating the corrections required.

(b) Two-Plane Balancing

The correction masses and their positions can be found using a method similar to that used in the single-plane case, but the calculations are rather complicated, so the pocket calculator is usually used. Example Two in Appendix 1 is a worked example of the use of this method.

A Mass Resolution Example: Balancing a Fan

Fig.18 shows an example of a five-bladed fan, where mass corrections can only be made on the blades, i.e. there are only five permitted correction positions, with an angle of 72° between permitted positions. If, as a result of a balancing job, the correction mass is found to be 2g and the correction angle 100° , it seems impossible to mount the correction mass. The solution is to divide the correction mass between the blades at 72° and 144° .

This can be done using a vector diagram, but it is more easily done using an HP41C calculator and WW9021 Balancing Program.

With the Balancing Program, the procedure is as follows:

Press [RESOL]. The following data are then requested in turn:

CRM: Required correction mass; 2g in our example;

CR \angle : Required correction angle, measured from one of the permitted positions (new zero); 28° in our example, ($100^\circ - 72^\circ$);

RES \angle : The angle between the two permitted positions; in this case, 72° .

The calculator then calculates and displays, in sequence, the resolved masses at position zero (*M \angle 0*) and the other permitted position (*M \angle RES*). For the given example, the calculator returns the following information:

$$M_{\angle 0} = 1,5g \quad M_{\angle 72} = 1,0g.$$

This indicates that 1,5g of the 2g correction mass should be mounted on the 72° blade, and the other 1,0g should be mounted on the 144° blade.

Instrumentation for Balancing

Some of the instruments available for balancing have been specially designed for this purpose, while others are vibration measuring or analysing instruments which can also be used for balancing.

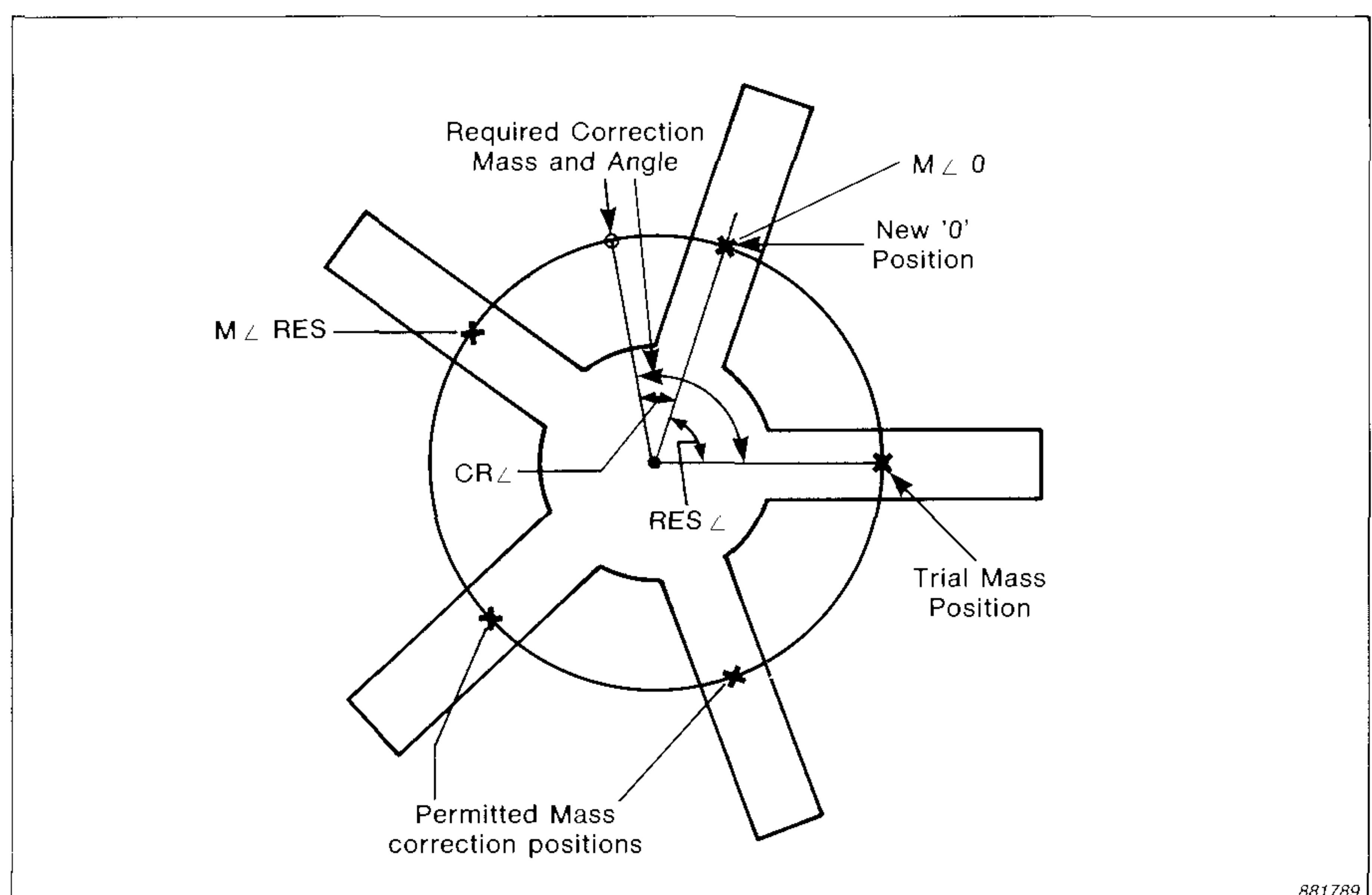

Fig. 18. Dividing a correction mass into two components for mounting on a five-bladed fan

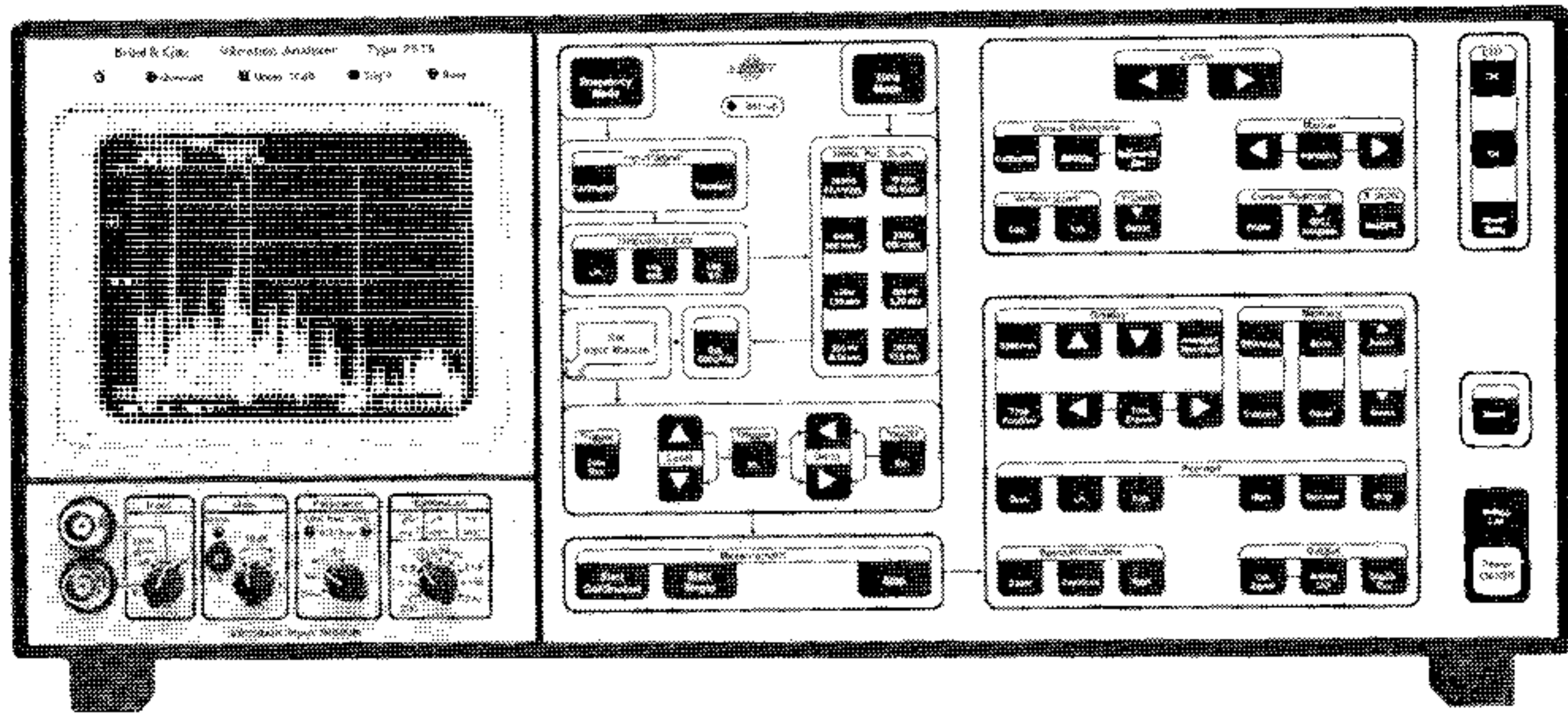

Fig. 19. To the left, the Vibration Analyzer Type 2515. To the right, balancing a 275 MW turbo-generator set at Kyndbyværket power station

When choosing an instrument for balancing, it is important to look at the other things it can do. Likewise, when selecting equipment for general vibration measurement or machine condition monitoring, it is important to consider whether it can be adapted easily for balancing.

Brüel & Kjær offers three instruments suitable for balancing rotors in situ. They are the Type 2515 Vibration Analyzer, and the Types 3517 and 3537 Balancing Sets.

Vibration Analyzer Type 2515

The portable Vibration Analyzer Type 2515, Fig. 19, is designed for both trouble-shooting machine vibration problems and day-to-day machine condition monitoring, but it is also ideal for use as a field balancing set.

The instrument is portable and has built-in rechargeable batteries. It has a strong construction designed to withstand daily use in the field, even under adverse environmental conditions.

For balancing, the following accessories are required: an MM0012 or MM0024 photoelectric probe, Type 4391 accelerometers (one for single-

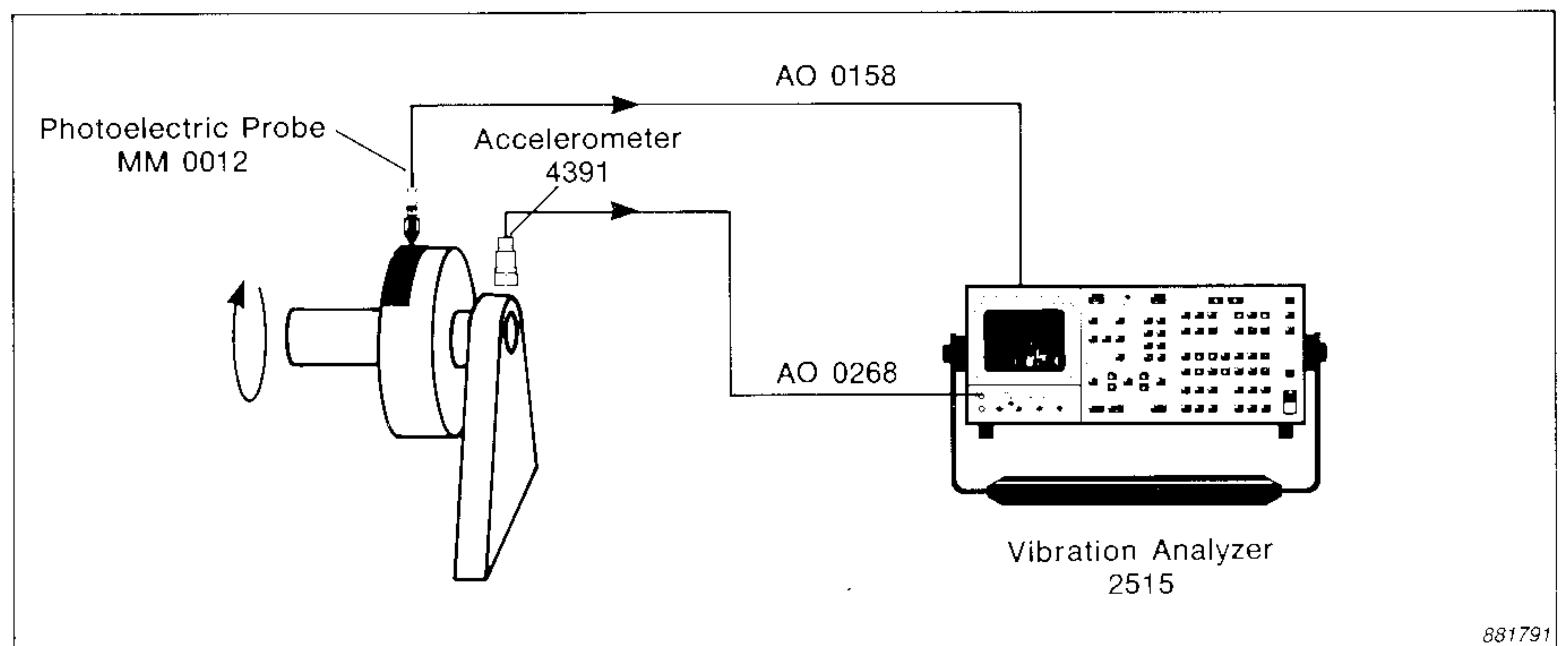

Fig. 20. Single-plane balancing with the Type 2515 Vibration Analyzer

plane balancing, two for two-plane) and connecting cables AO0268 and AO0158. The equipment set-up for single-plane balancing is shown in Fig. 20. For two-plane balancing, measurements must be made alternately in each plane, so a WB0968 Channel Selector can be used to enable switching between planes. A set-up for two-plane balancing is shown later in Fig. 31.

The vibration due to the unbalance is seen as a peak in the spectrum at the rotational frequency. The vibration level and phase can be read directly from the screen by placing the cursor on this peak. Any changes in

machine running speed can be seen clearly in the spectrum on the display screen, and the cursor position can be adjusted accordingly, so that it coincides with the rotational frequency of the rotor.

Unstable rotor speeds can sometimes cause problems with phase measurements, due to the peak at the rotational frequency not falling exactly on one of the lines of the analyzer's screen. If this is a problem, a tracking frequency multiplier **Type 5859** or **5050** can be used to advantage to obtain an exact, steady phase-reading for balancing. A tracking frequency multiplier monitors the machine speed via

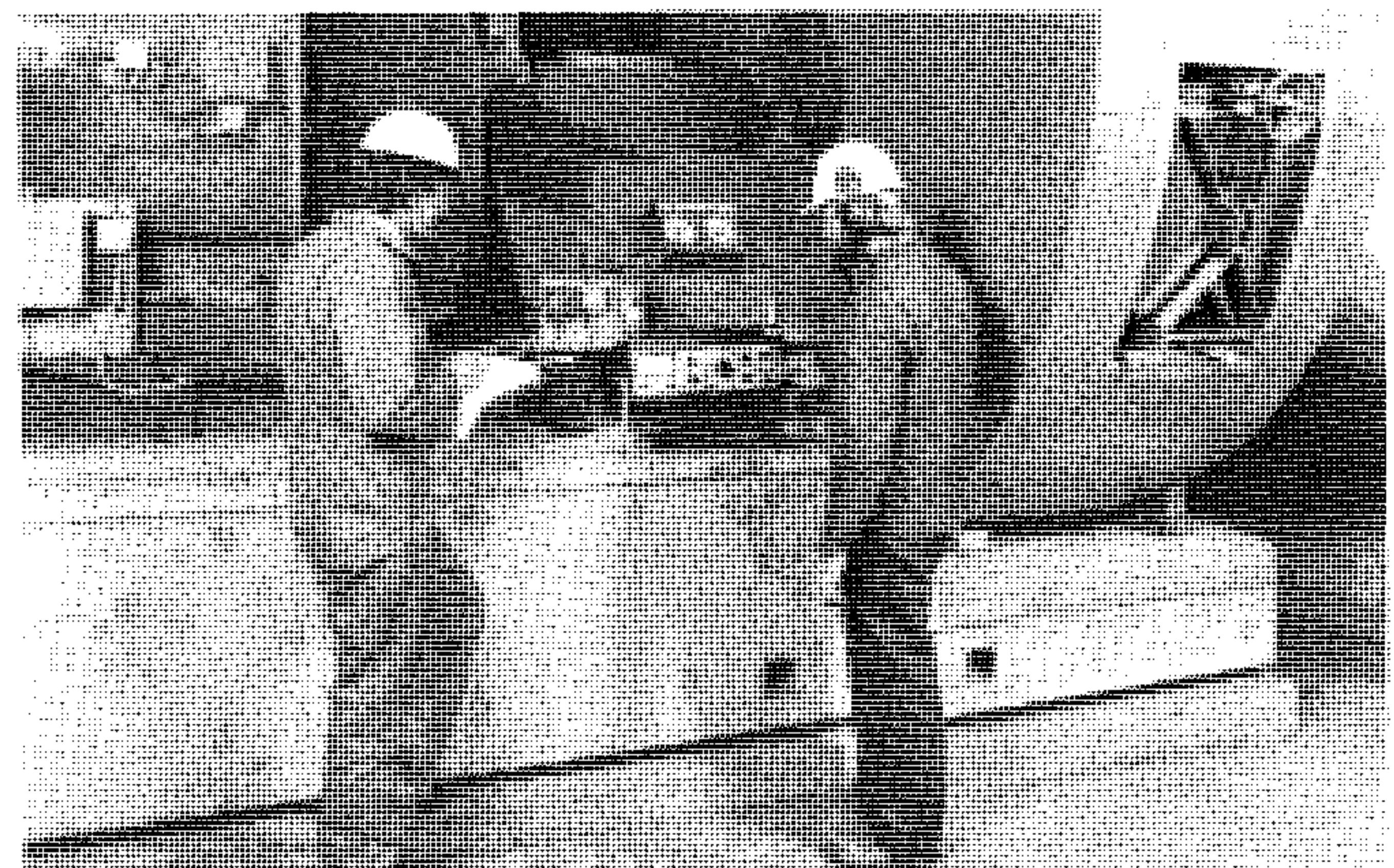
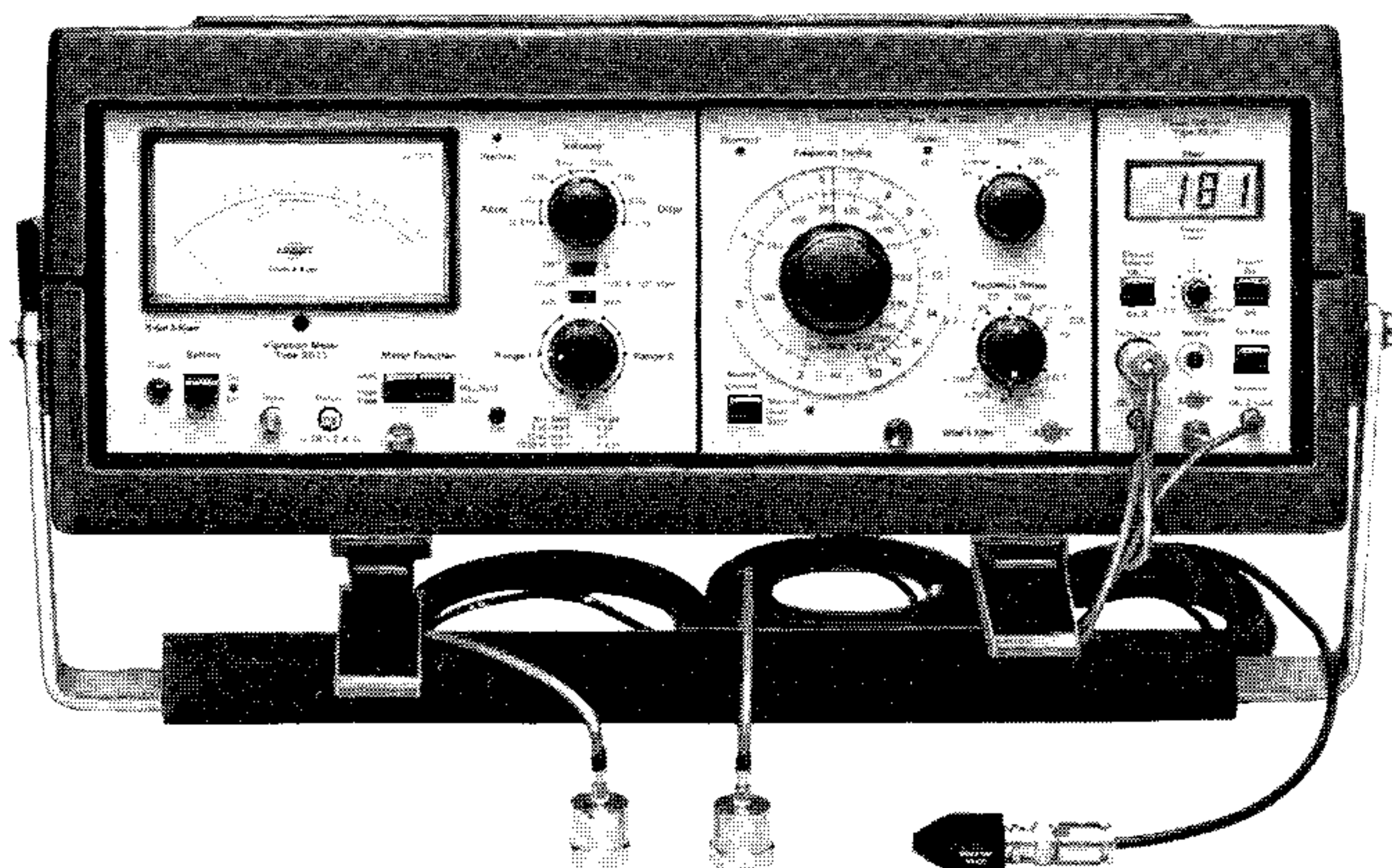

Fig. 21. To the left, the Balancing Set Type 3517. To the right, balancing a 1300 kW primary air blower at Signæs power station

the tachprobe and controls the external sampling of the analyzer. If the machine speed changes, the analyzer sampling frequency will change proportionally so that the peak at the rotational frequency always remains at the same line on the screen.

Another useful feature of the 2515 is its facility for storing, retrieving and comparing spectra. The vibration spectra for before and after balancing should be stored in memory, so that the reduction in vibration due to balancing can be seen. Also the spectra of the balanced and unbalanced machine can be directly compared using the MEMORY "Compare" function.

Field Balancing Set Type 3517

The portable Balancing Set Type 3517, Fig.21, is an ideal tool for field balancing of rotors. The set is supplied in a hard-foam carrying-case, together with built-in rechargeable batteries.

The set consists of a Type 2511 Vibration Meter and a Type 1621 Tunable Band Pass Filter (which together comprise the Type 3513 Vibration Analyzer) plus a Type 2976 Phase Indicator. As well as for balancing, the 3517 can be employed for the same wide range of vibration analysis functions as the 3513, and therefore forms a very useful dual-purpose analysis tool.

Two Type 4370 Piezoelectric Accelerometers are supplied with the set, together with a Photoelectric Tachometer Probe MM0012 and connection cables.

Fig. 22 shows how the 3517 operates. The vibration signal from one of the

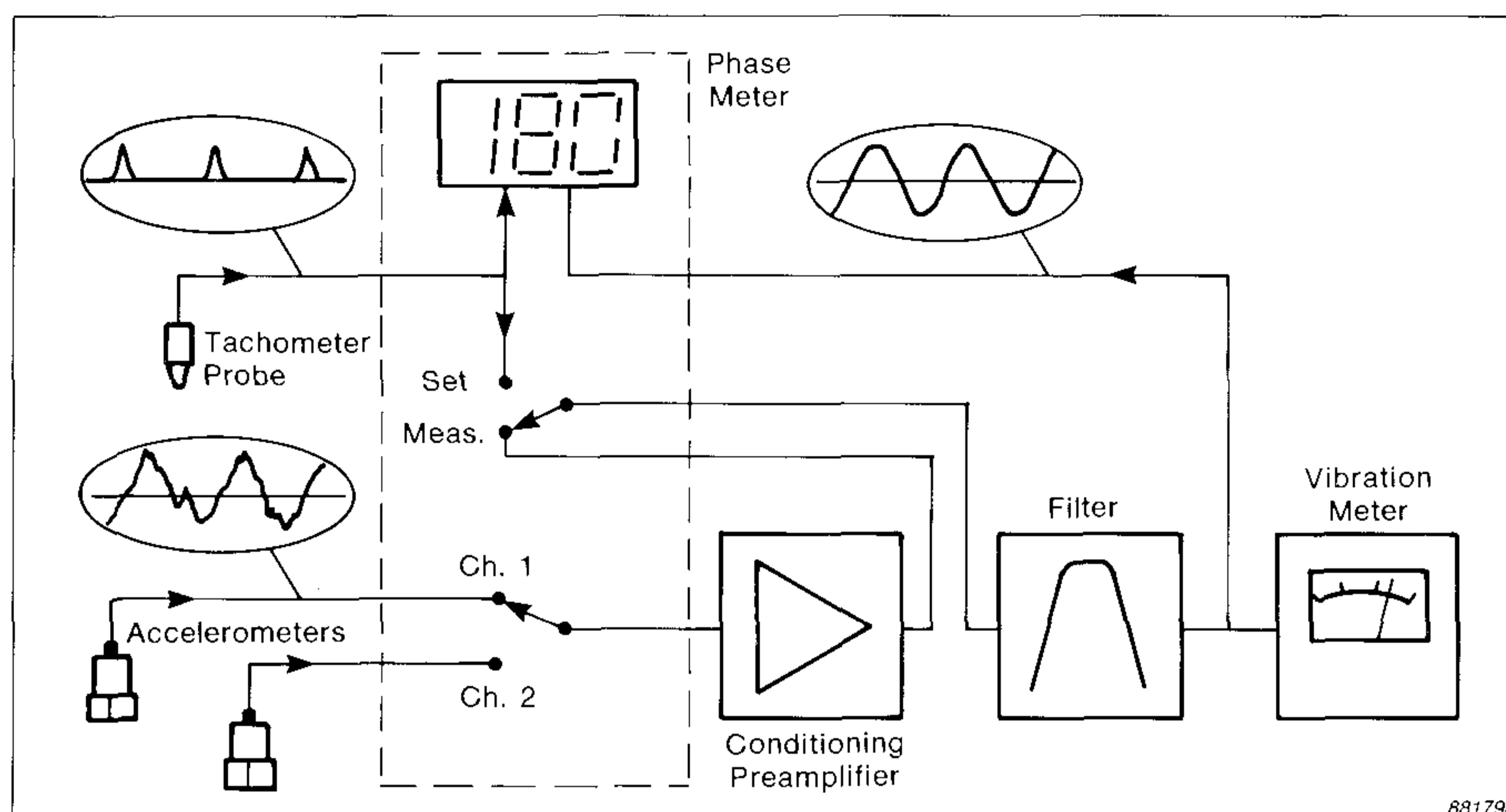

Fig. 22. Signal paths in the Type 3517 Balancing Set

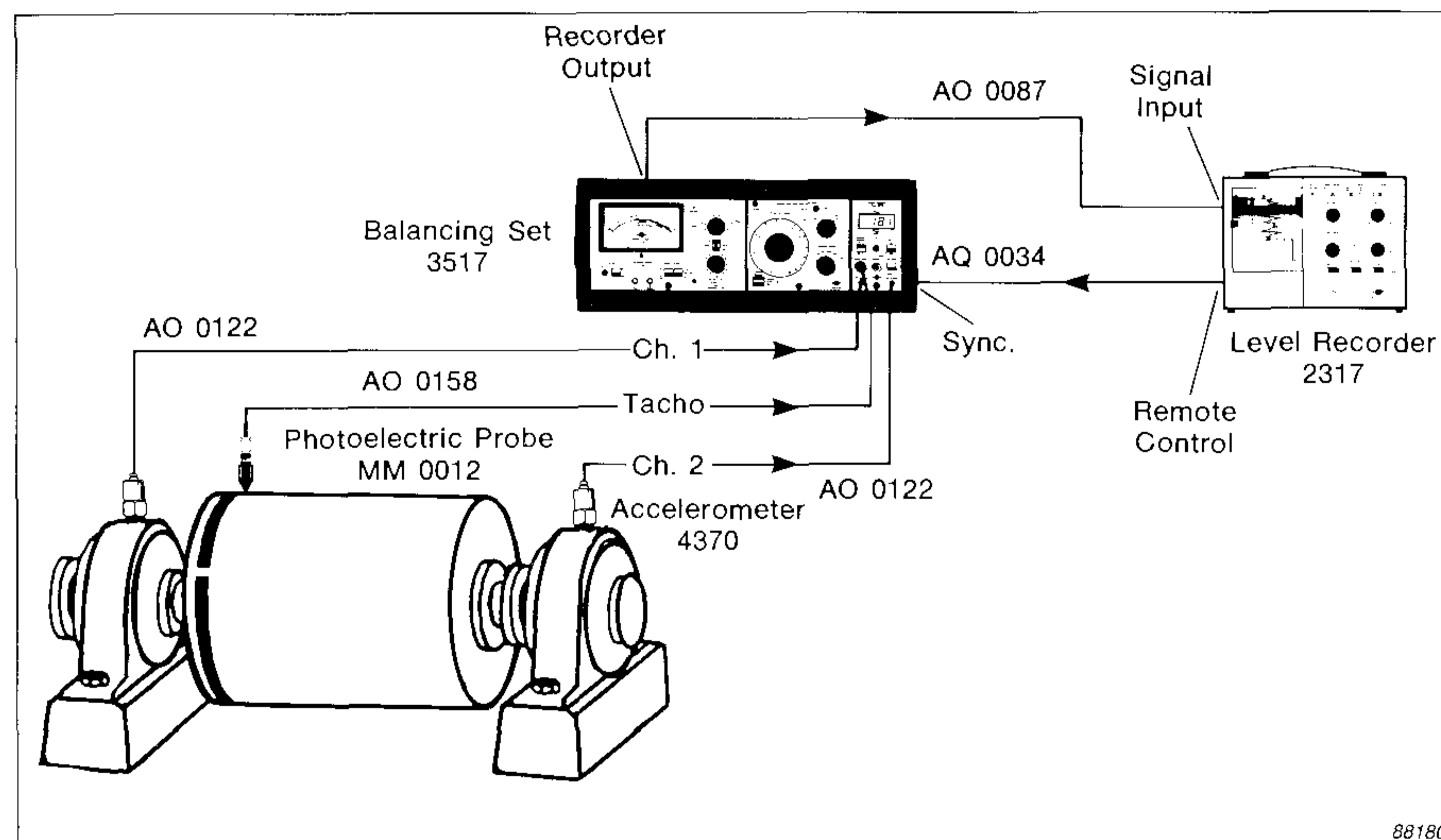

Fig. 23. Two-plane balancing with the Type 3517 Balancing Set

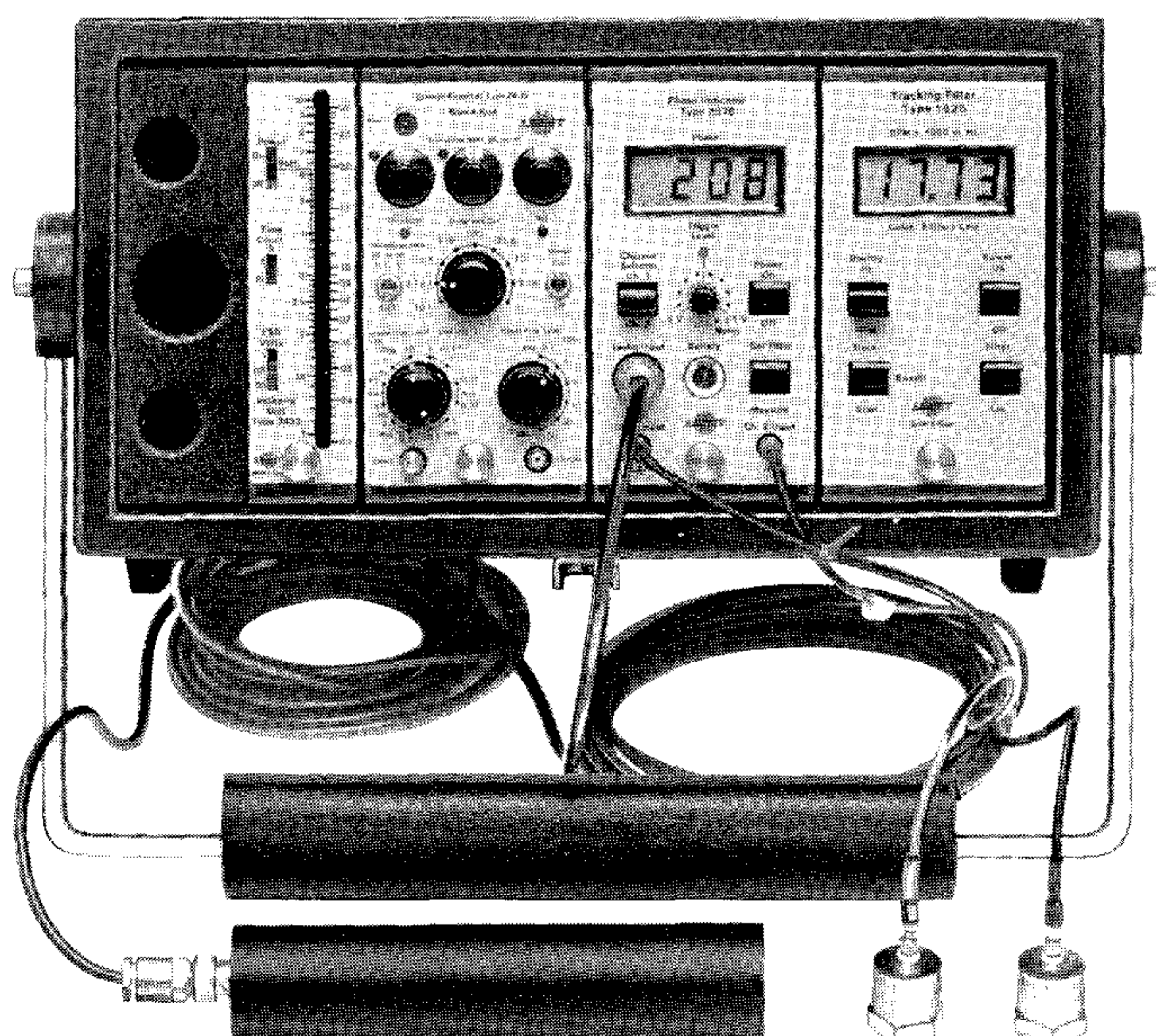

Fig. 24. To the left, the Balancing Set Type 3537. To the right, balancing a Alfa-Laval NX 418 decanter centrifuge

accelerometers is chosen using the "Ch.1/Ch.2" CHANNEL SELECTOR switch. This signal is amplified and passed through the filter, which is tuned to the rotational frequency of the rotor. The level of vibration is displayed by the vibration meter. The phase indicator compares the signal from the tachoprobe with the filtered accelerometer signal and displays the phase between them. The equipment set-up is shown in Fig. 23.

Field Balancing Set Type 3537

The Field Balancing Set Type 3537, shown in Fig. 24, is similar to the Type 3517. The principal difference between the two is the tracking filter, incorporated into the Type 3537. The 3537 is ideal for applications where a narrowband tracking filter is necessary, e.g. when balancing at fluctuating speeds, or to suppress vibrations from other sources. Automatic frequency analyses up to 2kHz are also possible with the set.

The set consists of a Type 2635 Pre-amplifier, a Type 2433 Indicator Unit, a Type 1626 Tracking Filter, and a Type 2976 Phase Indicator. Two Type 4370 Piezoelectric Accelerometers, an MM0024 Photoelectric Tachoprobe and connecting cables complete the set. The set is supplied in a carrying case, together with rechargeable batteries.

Fig. 25 shows a simplified block diagram of the signal paths in the 3537, and Fig. 26 the equipment set up. The tachoprobe provides one pulse per revolution of the rotor. The filter is then automatically and continuously adjusted so that it is always correctly tuned to the rotational frequency of the rotor. The automatic tuning means that the 3537 can give stable phase readings, even when there are small fluctuations in rotor speed.

Three filter bandwidths are available: 0.1 Hz (up to 20 Hz), 1 Hz (20 to 200 Hz), and 10 Hz (200 Hz to 2 kHz). However, if required, it is possible to select any of these filter bandwidths over the entire frequency range. This is a useful feature when, for example, there is another peak in the spectrum close to the rotational frequency of the rotor and it is necessary to measure the amplitude of one of these peaks.

The vibration signal from one of the accelerometers is amplified and filtered, and the level of the signal component at the rotational frequency is

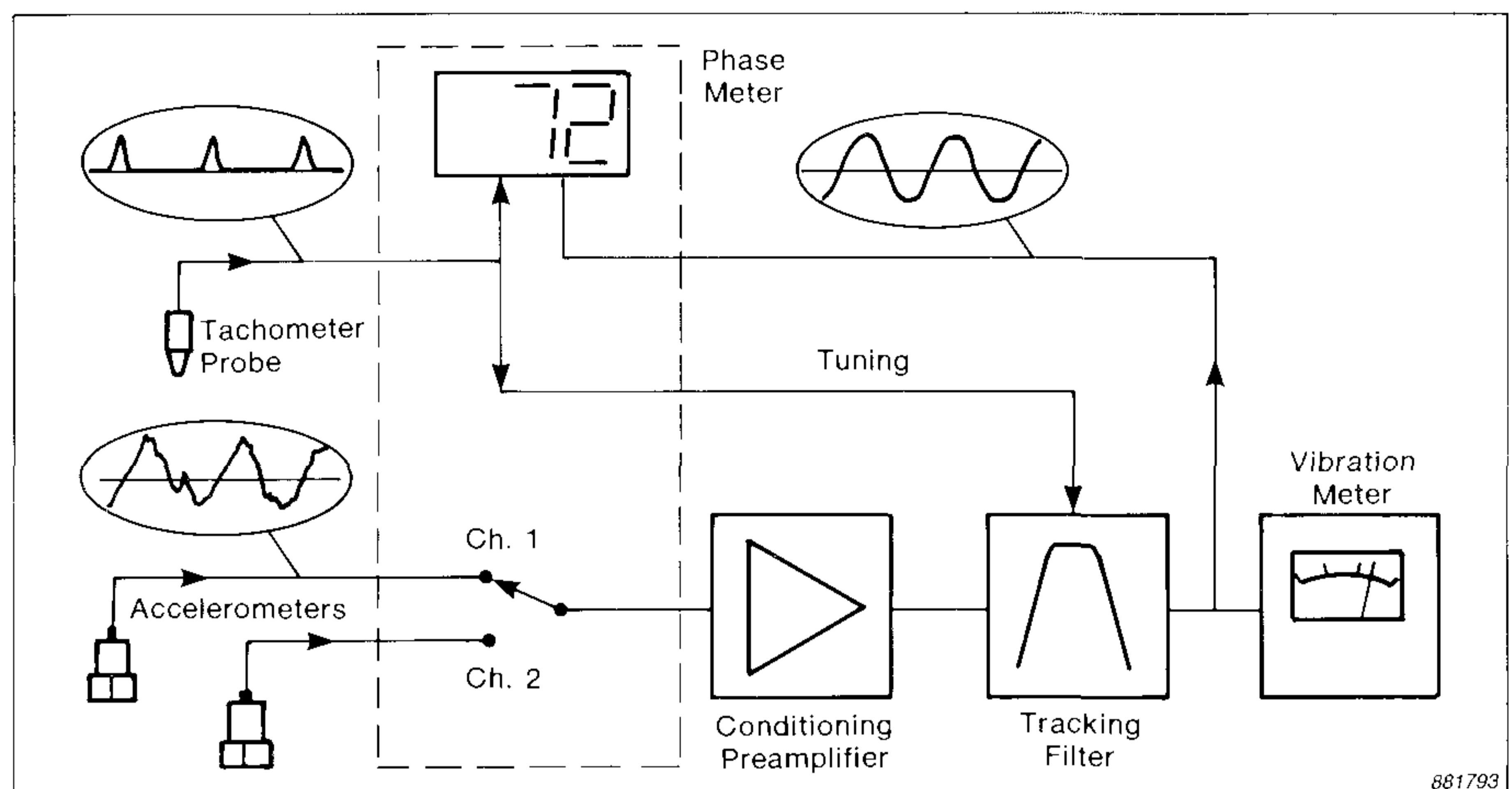

Fig. 25. Signal paths in the Type 3537 Balancing Set

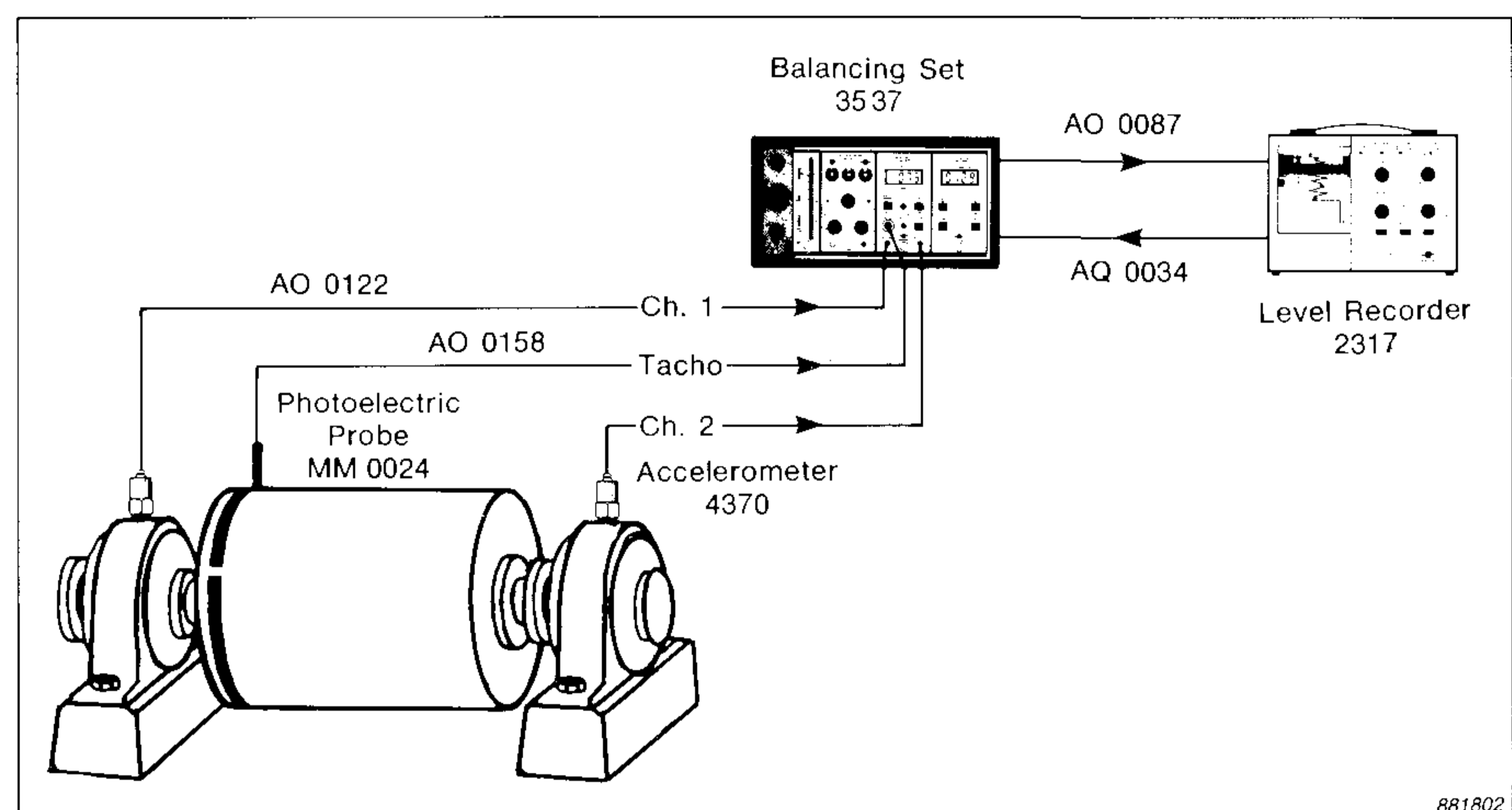

Fig. 26. Two-plane balancing with the Type 3537 Balancing Set

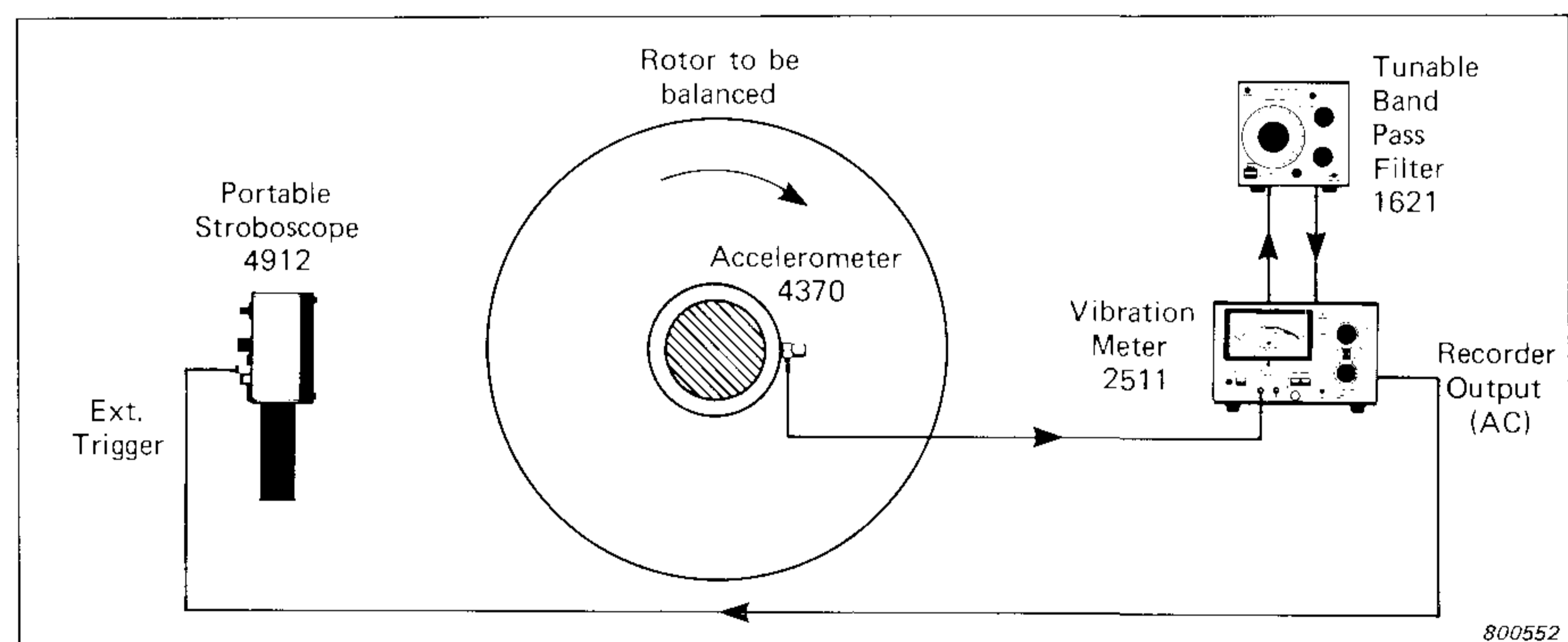

Fig. 27. Using a stroboscope to measure phase angles

displayed on the Indicator Unit. The Phase Indicator measures and displays the phase between the pulse signal from the tachoprobe and the filtered vibration signal.

Using a Stroboscope to Measure Phase Angles

The alternative instrumentation shown in Fig. 27 can be used for balancing, where proper balancing equipment is not available.

The vibration level is measured using a Type 3513 Portable Vibration Analyzer, which consists of a 2511 Vibration Meter and a 1621 Tunable Band Pass Filter.

Instead of using a Phase Indicator to measure the phase, a Type 4912 Portable Stroboscope is employed. A scale graduated in angular units is taped or marked on the rotor. The scale is illuminated during trial bal-

ancing runs with the light from the stroboscope, which is triggered by the filtered vibration signal. The phase of the vibration signal is then simply read from the scale.

Portable Level Recorder Type 2317

The three instruments described above can all be used with the Portable Level Recorder Type 2317 to produce a hard copy of the frequency spectrum. The 2317 is a handy, completely self-contained level recorder designed for field use. Rechargeable batteries and an (optional) leather carrying-case make it truly portable.

With the Balancing Sets Types 3517 and 3537, the Level Recorder is used to obtain a picture of the frequency spectrum, which can be used for fault diagnosis. Spectra of the machine vibration before and after balancing can be produced so that the reduction in vibration due to the balancing can be clearly seen.

The Vibration Analyzer Type 2515 displays a spectrum for immediate fault diagnosis, but the Level Recorder is very useful if a hard copy is required. An example of a hard-copy from the 2515/2317 is shown in Fig. 28, note how the 2515 measurement set-up is also given on the hard-copy recording.

Photoelectric Probes Types MM0012 and MM0024

One final note on instrumentation concerns photoelectric tachometer probes. Brüel & Kjær offers two probes for use with balancing equipment. Both probes are of the non-contact type and they function by projecting a beam of infra-red light at the rotor surface and generating an electrical signal related to the proportion of light reflected back. Triggering is indicated by a periodic change in the value of this signal.

The MM0012 has an operating distance of between 1 and 20 mm from the rotor. The probe is triggered by a contrast mark on the rotor. The circumference of the rotor, in the plane where the probe is to be mounted, is first covered by a band of matt black tape or paint.

The MM0024 probe has an operating distance of 50 to 800 mm from the rotor. A matt black background is not necessary, as the probe is triggered only by special, hexagonally patterned reflective tape QA0137, supplied with

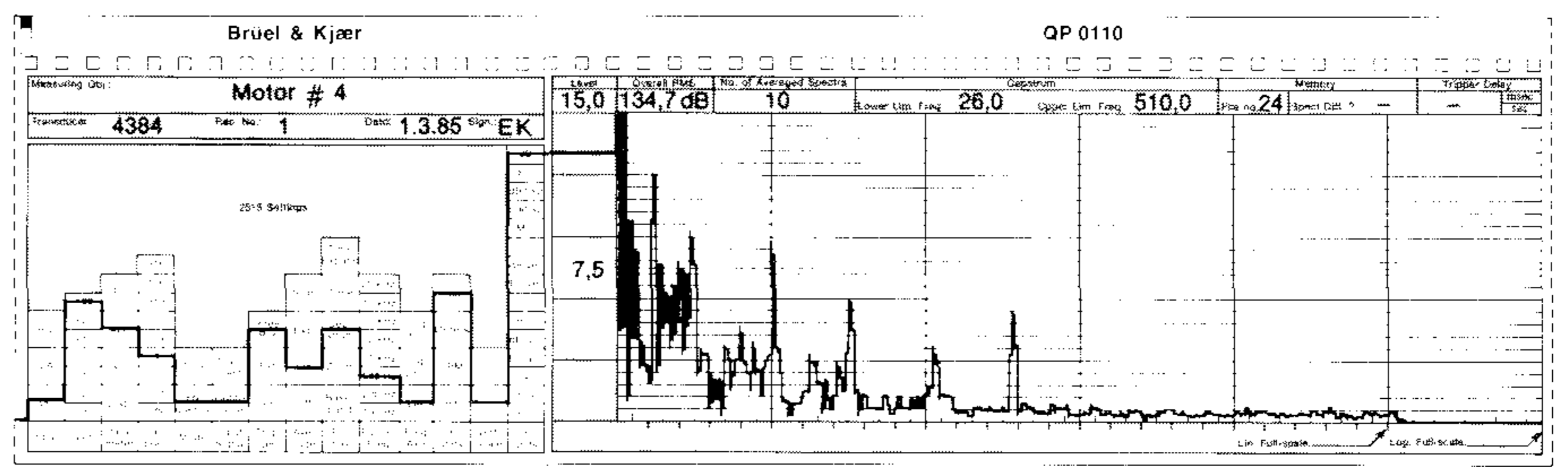

Fig. 28. Frequency spectrum from the Type 2515 plotted on a Level Recorder Type 2317

the probe. An LED on top of the probe flashes to indicate triggering.

The MM0012 probe is supplied with the 3517 Balancing Set, while the MM0024 is supplied with the 3537 Balancing Set. All three instruments, the 3517, the 3537 and the 2515, can use either probe for triggering.

Appendix 1: Worked Examples

Example One:

To balance a rotor statically using the equipment shown in Fig. 29.

Measurement of peak-to-peak vibration velocity level was selected on the Vibration Meter, and a bandwidth of 3% on the Band Pass Filter. The machine was run up to its normal operating speed, 1490 r/min, after which the Band Pass Filter centre frequency was adjusted to the rotation frequency. A vibration level of 3,4 mm/s was recorded, and when the bandwidth was broadened to 23%, the Phase Meter indicated +116°.

The machine was stopped, and a 2 g trial mass was fixed to it. When the machine was run up to speed again, the vibration velocity level was found

to have decreased to 1,8 mm/s, while the phase angle had changed to +42°.

The position and magnitude of the compensating mass were determined from the vector diagram shown in Fig. 30.

The original unbalance is given by:

$$\begin{aligned} M_O &= \frac{|V_O|}{|V_T|} \times M_T \\ &= \frac{3,4}{3,35} \times 2 \\ &= 2,03 \text{ g.} \end{aligned}$$

So the compensating mass

$$M_{COMP} = 2,03 \text{ g}$$

and its position is given by

$$\begin{aligned} \angle_{COMP} &= -\angle_T + \angle_O + 180^\circ \\ &= -327^\circ + 116^\circ + 180^\circ \\ &= -31^\circ \text{ referred to the position of the trial mass.} \end{aligned}$$

As the angle indicated is negative, the compensating mass is to be fastened at an angle of 31° from the position where the trial mass was mounted, measured in the opposite direction to the direction of rotation.

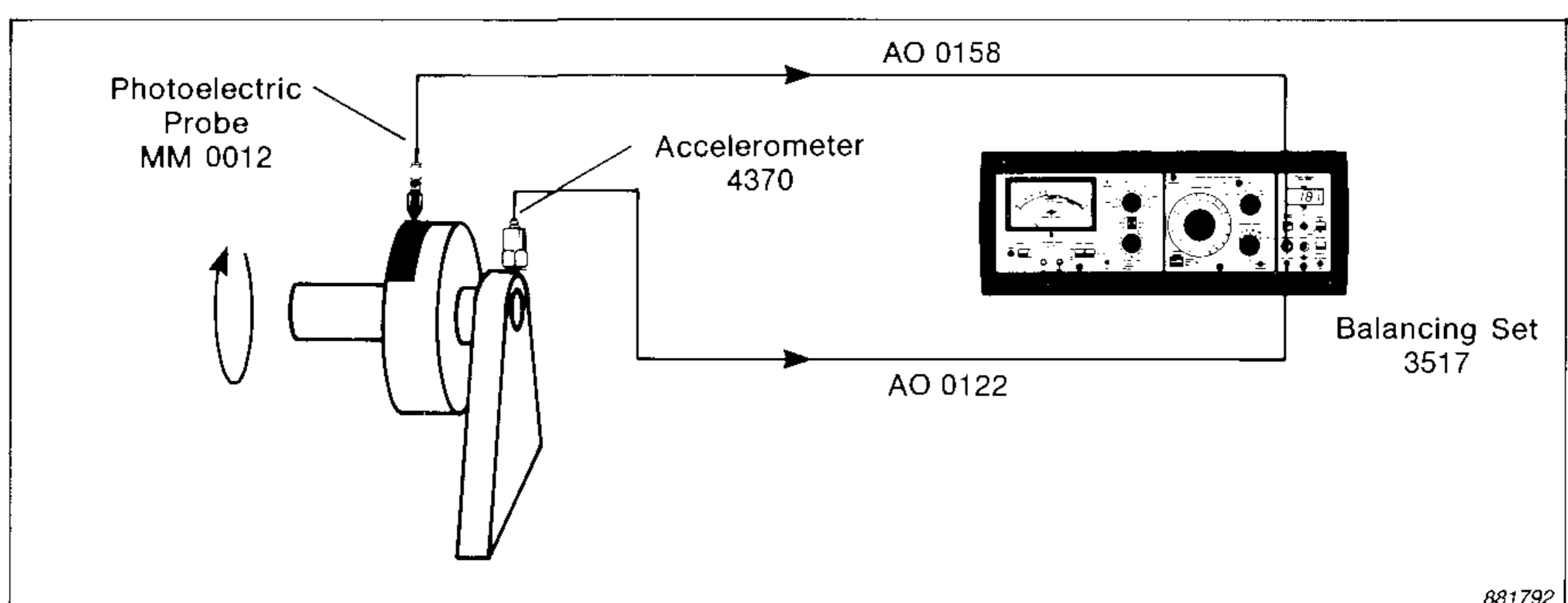

Fig. 29. Instrument set-up for Example One

Example Two:

Performing two-plane (dynamic) balancing on a machine that has a rigid rotor supported in two bearings.

The equipment was set up as shown in Fig.31. A WB0968 Channel Selector was employed to enable switching between the two measurement planes.

To avoid special emphasis of high or low frequency components, vibration velocity was chosen as the measurement parameter. Using the Y-UNITS button, the velocity units were set to m/s.

The machine was run up to its normal service speed and, with the cursor positioned at the rotational speed of the rotor, the initial vibration level for plane 1 was read from the display screen and noted in the Balancing Report. Pushing the "Phase" button, the **Phase** was read from the screen, and its value was noted.

Choosing channel 2 on the Channel Selector, the initial vibration level and phase were measured and recorded, in the same way, for plane 2. The values recorded are shown in Table 3.

The machine was stopped and a 2,5g trial mass was mounted at a suitable position in plane 1, and its position marked. The level and phase measurements for both planes were repeated and the data recorded.

The machine was stopped and the same 2,5g trial mass was attached to plane 2 and its position marked. The measurement and data recording procedure was repeated.

Using the data shown in Table 3, the masses and angles required to balance the rotor were calculated, using two different methods: firstly by means of an HP41 CV calculator and WW9021 Balancing Program, and secondly, using the vector diagram method.

The calculator returned the following values for the correction masses and angles:

Plane 1:

3,0g at an angle of 50,2° from the position of the trial mass, measured in the direction of rotation, i.e. + 50,2°.

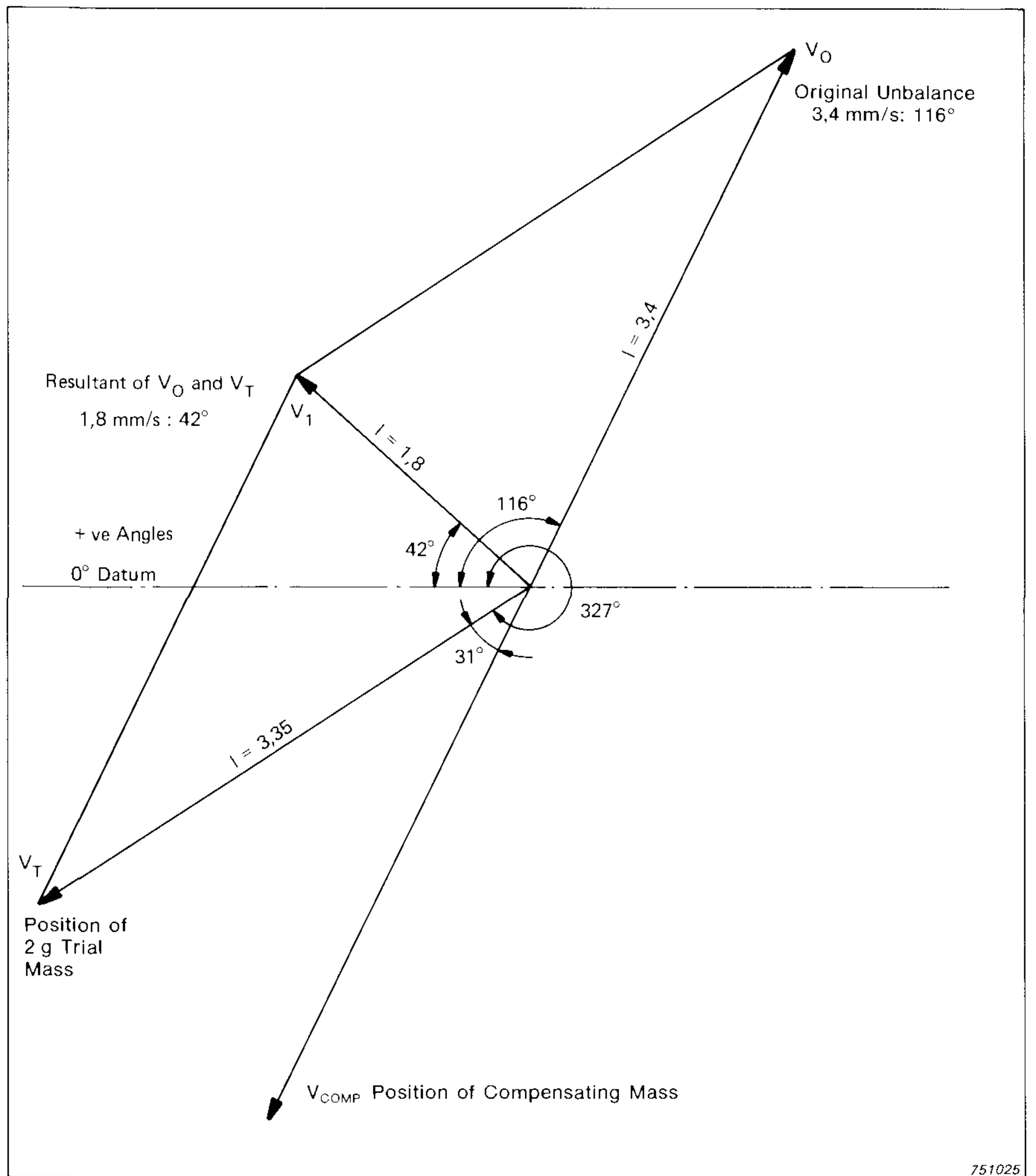

Fig. 30. Vector diagram for Example One

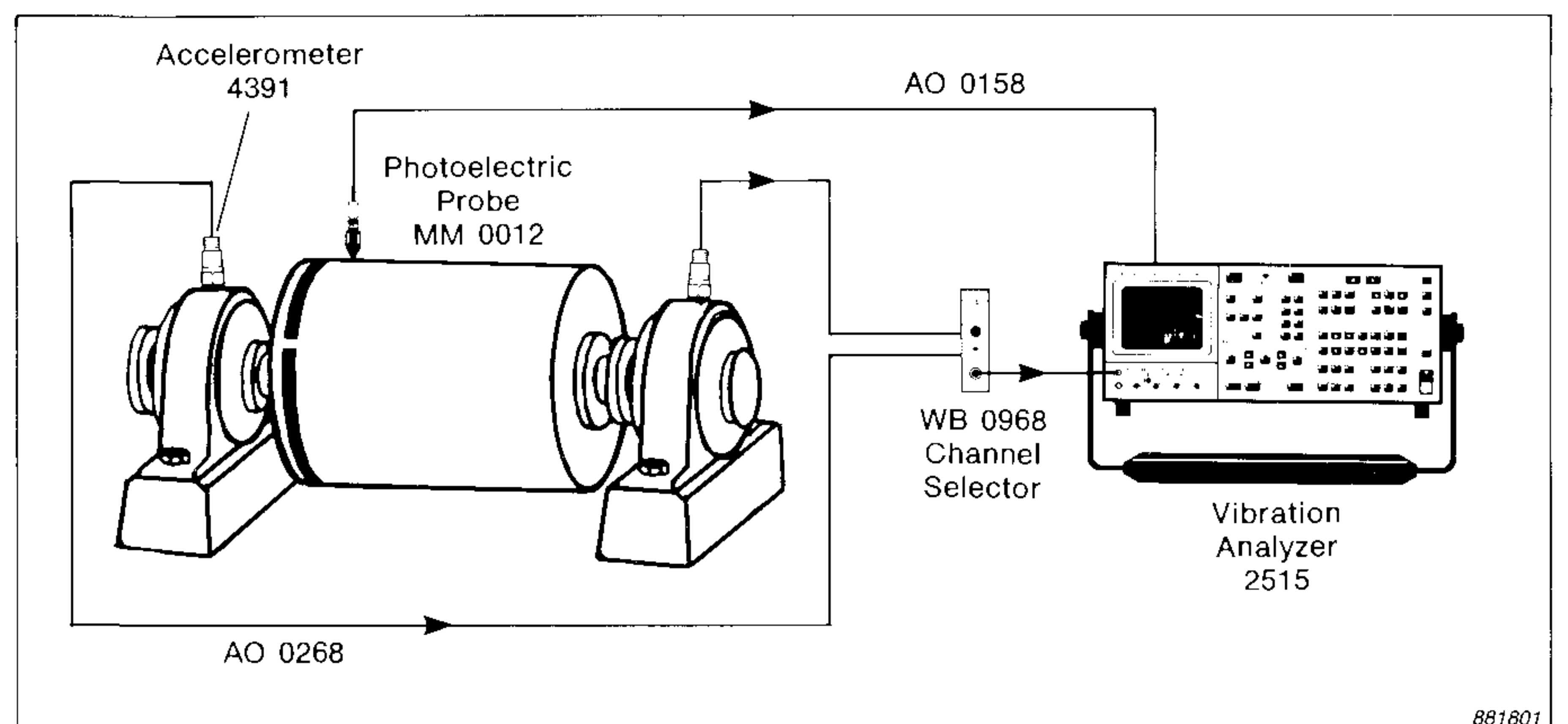

Fig. 31. Instrument set-up for Example Two

Trial Mass Size and Location	Measured Effect of Trial Mass					
	Plane 1			Plane 2		
None	7,2 mm/s	238°	$\bar{V}_{1,0}$	13,5 mm/s	296°	$\bar{V}_{2,0}$
2,5 g Plane 1	4,9 mm/s	114°	$\bar{V}_{1,1}$	9,2 mm/s	347°	$\bar{V}_{2,1}$
2,5 g Plane 2	4,0 mm/s	79°	$\bar{V}_{1,2}$	12,0 mm/s	292°	$\bar{V}_{2,2}$

Table 3. Measured vibration levels and phase angles for Example Two

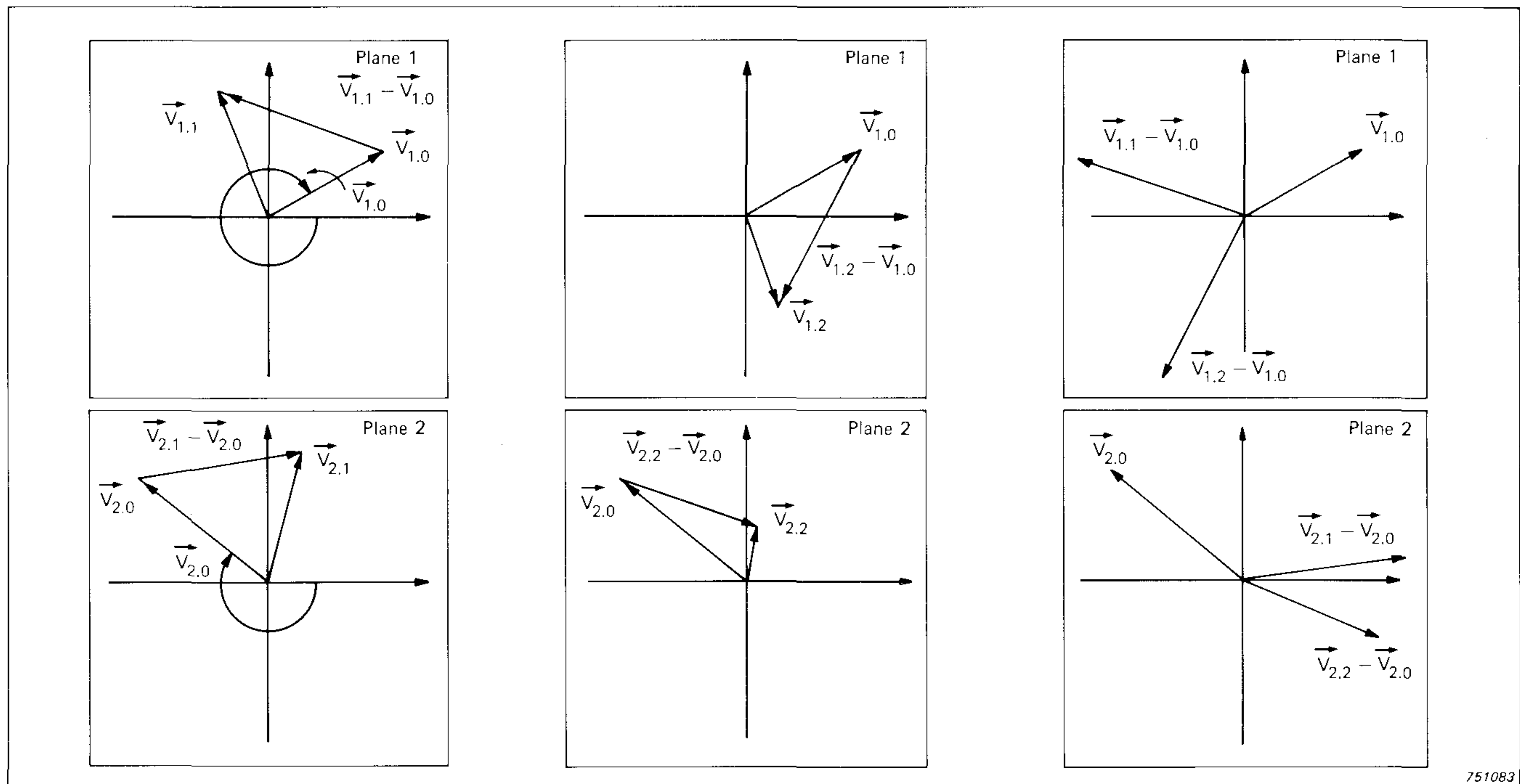

Fig. 32. Vectorial representation of the vibration levels

Plane 2:

2,8g at an angle of $81,9^\circ$ from the position of the trial mass, measured against the direction of rotation, i.e. $-81,9^\circ$.

Using the vector diagram method to calculate the correction masses and angles, the first step was to represent the measured vibration levels in vector diagram form, see Fig.32.

In vector notation:

$\vec{V}_{1,0}$ is the original unbalance measured in Plane 1.

$\vec{V}_{2,0}$ is the original unbalance measured in Plane 2.

$\vec{V}_{1,1} - \vec{V}_{1,0}$ is the effect in Plane 1 of a trial mass mounted in Plane 1.

$\vec{V}_{1,2} - \vec{V}_{1,0}$ is the effect in Plane 1 of a trial mass mounted in Plane 2.

$\vec{V}_{2,1} - \vec{V}_{2,0}$ is the effect in Plane 2 of a trial mass mounted in Plane 1.

$\vec{V}_{2,2} - \vec{V}_{2,0}$ is the effect in Plane 2 of a trial mass mounted in Plane 2.

Mathematically, the problem was to find two vector operators \hat{Q}_1 (with vector length Q_1 and phase angle γ_1) and \hat{Q}_2 (with vector length Q_2 and phase angle γ_2), which satisfy the following equations:

$$Q_1 (V_{1,1} - V_{1,0}) + Q_2 (V_{1,2} - V_{1,0}) = -V_{1,0} \quad (1)$$

$$Q_1 (V_{2,1} - V_{2,0}) + Q_2 (V_{2,2} - V_{2,0}) = -V_{2,0} \quad (2)$$

Writing Q_1 in terms of Q_2 in Equation (1), we get: $Q_1 = \frac{-V_{1,0} - Q_2 (V_{1,2} - V_{1,0})}{V_{1,1} - V_{1,0}} \quad (3)$

Substituting for Q_1 in Equation (2), and writing it all in terms of Q_2 :

$$Q_2 = \frac{V_{2,0} (V_{1,1} - V_{1,0}) - V_{1,0} (V_{2,1} - V_{2,0})}{(V_{2,1} - V_{2,0})(V_{1,2} - V_{1,0}) - (V_{2,2} - V_{2,0})(V_{1,1} - V_{1,0})} \quad (4)$$

The measured values of vibration level and phase angle are the polar coordinates for the vector quantity \vec{V} . When a Cartesian system of coordinates is used, with real and imaginary components, where $\vec{V} = a + jb$ a mathematical solution for Equations (3) and (4) can be calculated.

Polar coordinates are converted to Cartesian coordinates by means of the two equations:

$$a = V \cos \gamma, \text{ and } b = V \sin \gamma$$

Converting to Polar coordinates, the values in Table 4 (shown overleaf) can be calculated, for example:

$$V_{1,1} - V_{1,0} = (-2,0 + 4,48j) - (-3,82 - 6,12j) = (+1,82 + 10,6j)$$

751083

v	v	γ	a	jb
$\bar{V}_{1,0}$	7,2	238°	-3,82	-6,12j
$\bar{V}_{1,1}$	4,9	114°	-2,0	+4,48j
$\bar{V}_{1,2}$	4,0	79°	+0,76	+3,93j
$\bar{V}_{2,0}$	13,5	296°	+5,92	-12,13j
$\bar{V}_{2,1}$	9,2	347°	+8,96	-2,07j
$\bar{V}_{2,2}$	12,0	292°	+4,5	-11,13j
$(\bar{V}_{1,1} - \bar{V}_{1,0})$			+1,82	+10,60j
$(\bar{V}_{2,1} - \bar{V}_{2,0})$			+3,04	+10,06j
$(\bar{V}_{1,2} - \bar{V}_{1,0})$			+4,58	+10,05j
$(\bar{V}_{2,2} - \bar{V}_{2,0})$			-1,42	+1,00j

T01941GB0

Table 4. Conversion of coordinates in Example Two

Substituting the values in Table 4 into Equation 4:

$$Q_2 = \frac{(+5,92 - 12,13j)(+1,82 + 10,60j) - (-3,82 - 6,12j)(+3,04 + 10,06j)}{(+3,04 + 10,06j)(+4,58 + 10,05j) - (-1,42 + 1,00j)(+1,82 + 10,60j)}$$

which simplifies to:

$$Q_2 = +0,1598 - 1,1264j$$

which can be reconverted to polar coordinates by means of the following equations:

$$V = +\sqrt{a^2 + b^2}$$

for $a > 0$

$$\gamma = \tan^{-1} \frac{b}{a} \quad -90^\circ < \gamma < +90^\circ$$

for $a < 0$

$$\gamma = 180^\circ + \tan^{-1} \frac{b}{a} \quad +90^\circ < \gamma < +270^\circ$$

So that vector length

$$Q_2 = 1,1376$$

and phase angle

$$\gamma_2 = -81,9^\circ$$

Substituting into Equation 3, the value of Q_1 can be found:

$$Q_1 = \frac{-(-3,82 - 6,12j) - (+4,48 + 10,05j)(+0,1598 - 1,1264j)}{(+1,82 + 10,6j)}$$

which simplifies to: $Q_1 = +0,7468 + 0,9033j$

Converting to polar coordinates $Q_1 = 1,1720$, $\gamma_1 = +50,4^\circ$

The balancing masses required to counteract the original unbalance are as follows:

Plane 1:

$$M_{COMP} = 1,172 \times 2,5 \text{ g} \\ (2,5 \text{ g being the trial mass}) \\ = 2,93 \text{ g at } +50,4^\circ.$$

Plane 2:

$$M_{COMP} = 1,1376 \times 2,5 \text{ g} \\ = 2,84 \text{ g at } -81,9^\circ$$

These results compare favourably with the results obtained using the programmable calculator.

Masses with these values were fastened in the respective planes on the rotor at the calculated angles, and at the radius used previously for the trial masses. A test run was made to assess the quality of the balance. Its results were as follows:

Plane 1:

vibration level = 0,5 mm/s, which represents a reduction in vibration velocity level of 93% from the original 7,2 mm/s.

Plane 2:

vibration level = 0,4 mm/s, which represents a reduction in vibration velocity level of 97% from the original 13,5 mm/s.

As an added test, the two balance masses were moved through an angle of 10°, to show the importance of phase angle determination. When the machine was run again, the vibration velocity level at Plane 1 was found to be 1,8 mm/s, with 2,2 mm/s at Plane 2. These results illustrate the importance of the really accurate phase angle determination possible with Brüel & Kjær equipment.

Appendix 2: Fault Tracing

This appendix lists possible faults encountered when balancing and suggests remedies.

1. If the tachoprobe is triggering properly, the yellow “Trigger Level” lamp of the Type 2976 Phase Indicator or the red “Trig’d” LED of the 2515 Vibration Analyzer should be lit (or flashing, if the rotor is rotating slowly). An LED on top of the MM0024 Photoelectric Probe should flash to indicate triggering. If the tachoprobe is not triggering properly, then the following should be checked:
 - (a) The orientation of the tachoprobe.
 - (b) That the correct tacho cable AO0158 has been used.
 - (c) It may be necessary to mask the tachoprobe from external light sources.
 - (d) If still no triggering, check the batteries in the instruments.
2. If the tachoprobe is triggering properly, but the display of the 2976 indicates “E” for “Error” or is blank, or the 2515 display shows **N. A. DEG** as a **Phase** reading, or the phase reading on either instrument is not steady within $\pm 2^\circ$, then the error is probably due to one or more of the following problems:
 - (a) Erratic rotor speed variations. Check the rotor speed and ensure that sufficient time is allowed for the speed to stabilize before measurements are made.
 - (b) The presence of more than one mark on the rotor. Check the reflection mark.
 - (c) The photoelectric probe is picking up reflections from flickering light sources. Try moving the probe to another position.
 - (d) The photoelectric probe is vibrating at a level above its limit. Remove it from the vibrating body or stiffen the probe support.
 - (e) The unbalance component of the vibration is insufficient for readings to be made.

Acknowledgements

Much of the material in this Application Note is based on Brüel&Kjær internal literature, in particular course

material on balancing prepared by Aage Courrech-Nielsen and Caitríona Ní Aonghusa.

BALANCING REPORT



Subject: _____

Vibration Meter Setting, Range: _____

Lower Limiting Frequency (LLF): _____ Meter Function: _____

Filter Setting, Bandwidth: _____ Frequency: _____

	Measuring plane 1		Measuring plane 2	
	Amplitude	Phase	Amplitude	Phase
Initial unbalance	1 A_{10}	2 \angle_{10} (7)	A_{20} (8)	\angle_{20}
Trial mass 1 in correction plane 1	3 A_{11}	4 \angle_{11} (9)	A_{21} (10)	\angle_{21}
Trial mass 2 in correction plane 2	(5) A_{12}	(6) \angle_{12} (11)	A_{22} (12)	\angle_{22}
	Trial mass 1		Trial mass 2	
	13		(14)	
	Correction plane 1		Correction plane 2	
	Mass	Angle	Mass	Angle
Corrections	15		(16)	
	Measuring plane 1		Measuring plane 2	
	Amplitude	Phase	Amplitude	Phase
Residual unbalance	A_{10}	\angle_{10}	A_{20}	\angle_{20}

Remarks: _____

Date: _____ Sign: _____

Brüel & Kjær, Nærum Hovedgade 18, DK-2850 Nærum, Denmark, Telefon: (02)800500

811077



WORLD HEADQUARTERS: DK-2850 Nærum · Denmark · Telephone: +45 280 05 00 · Telex: 37316 bruka dk · Fax: +45 280 14 05

Australia (02) 450-2066 · Austria 02235/7550*0 · Belgium 02-242-9745 · Brazil (011) 246-8149/246-8166 · Canada (514) 695-8225 · Finland (90) 8017044
 France (1) 64 57 20 10 · Federal Republic of Germany (04106) 4055 · Great Britain (01) 954-2366 · Holland 03402 39994 · Hong Kong 5-487486 · Italy (02) 52 44 141
 Japan 03-438-0761 · Republic of Korea (02) 554-0605 · Norway 02-78 70 96 · Portugal (1) 65 92 56/65 92 80 · Singapore 225 8533 · Spain (91) 268 10 00
 Sweden (08) 711 27 30 · Switzerland (042) 65 11 61 · Taiwan (02) 713 9303 · USA (508) 481-7000 · Local representatives and service organisations world-wide